



Aspirating Smoke Detection Applications Guide

Aspirating Smoke Detection

Installation Materials and Pipe Hangers	14
Installing Sampling Pipe Network.....	15
Commissioning	16
Testing and Maintenance.....	18
Troubleshooting Guide	19
Data Centres / Electronic Equipment Installations	21
Application Overview.....	21
Benefits of Aspirating Smoke Detection	21
Design Best Practices	22
More on Hot Aisle/ Cold Aisle Configurations	23
Coordination and Interface with other Systems	27
Common Issues/Application Troubleshooting	27
Dos.....	28
Don't.....	28
Telecommunications	29
Application Overview.....	29
Benefits of Aspirating Smoke Detection	30
Design Best Practices	31
Common Issues/Application Troubleshooting	37
Dos.....	38
Don'ts.....	38
Duct and Return Air Monitoring	39
Application	39
Benefits of ASD.....	39
Best Design Practices	39
Common Issues/Application Troubleshooting.....	42
Dos.....	42
Don'ts.....	42

Clean Rooms43	Best Design Practices66
Application Overview.....43	Common Issues/Application Troubleshooting.....69
Benefits of Aspirating Smoke Detection45	Hot Aisle Containment Area.....70
Design Best Practices46	Dos.....70
Common Issues/Application Troubleshooting49	Don'ts70
Dos.....50	Dirty Environments.....71
Don'ts.....50	Application Overview.....71
Large Volume Spaces51	Benefits of Aspirating Smoke Detection71
Application Overview.....51	Best Design Practices71
Benefits of Aspirating Smoke Detection52	Common Issues/Application Troubleshooting75
Design Best Practices52	Dos.....75
Ceiling Temp. 26° C (80° F), 90s Timeframe.....52	Don'ts75
Ceiling Temp. 42° C (108° F), 90s Timeframe.....52	References75
Common Issues/Application Troubleshooting59	Transportation Facilities76
Dos.....59	Application Overview.....76
Don'ts.....60	Benefits of Aspirating Smoke Detection76
References60	Design Best Practices77
Prisons and Restricted Areas60	Common Issues/Application Troubleshooting79
Application Overview.....61	Dos.....80
Benefits of Aspirating Smoke Detection61	Don'ts.....80
Design Best Practices62	References80
Common Issues/Application Troubleshooting.....63	Historic and Cultural Buildings81
Dos.....64	Application Overview.....81
Don'ts.....64	Benefits of Aspirating Smoke Detection82
References64	Design Best Practices84
Extreme Temperatures65	Dos.....84
Application65	Don'ts.....85
Benefits of ASD66	Glossary of Terms.....85

Aspirating Smoke Detection

An Aspirating Smoke Detection (ASD) System utilises an aspirator (fan) to actively draw air into a remote detector, through a sampling pipe network that extends into a protected space. This method of smoke/fire detection is sometimes referred to as Air Sampling Smoke Detection.

Codes and Standards

The installation, testing, and commissioning of aspirating smoke detection (ASD) systems is governed by several codes and standards. The following codes and standards are required to be referenced while designing ASD systems.

In Europe:

- Fire Detection and Fire Alarm Systems – Part 20: Aspirating Smoke Detectors (EN54-20); the standard for the installation of ASD systems in Europe
- In Europe, for each specific installation the local standards and codes of practice should be adhered to. Guidance on the design of systems is given in BS 5839, BS 6266 and/or FIA Code of Practice for the Design, Installation, Commissioning and Maintenance of Aspirating Smoke Detector (ASD) Systems

In the United States:

- National Fire Alarm and Signalling Code (NFPA 72)
- Standard for the protection of information Technology Equipment (NFPA 75)
- Standard for the Fire Protection of Telecommunications Facilities (NFPA 76)

Definitions

Sampling Hole:

Hole in a piping network that draws air by an aspiration device to an ASD.

Transport Time:

Time for the smoke particles to travel from the sampling point to the ASD.

Response Time:

Time between the smoke particles entering the sampling point and the notification of their presence at the ASD.

Maximum Transport Time:

Maximum allowable time to transport smoke particles from the sampling hole to response at the ASD; measured at the most remote or least sensitive sampling hole.

Sampling Piping Network:

Vehicle in which the sampled air is transported from the protected area to the detector.

European EN 54-20 Requirements

Within Europe, EN 54 Fire Detection and Fire Alarm Systems – Part 20: Aspirating Smoke Detectors (EN 54-20) outlines the requirements, test methods, and performance criteria for the use of ASD systems in fire detection systems.

There are many similarities between the European and United States installation and monitoring requirements. The definitions for the components are the same in both EN 54-20 and NFPA requirements:

- A fault signal shall be initiated when the airflow is outside the operational (manufacturer's) specified range.
- The airflow through the ASD and sampling pipe shall be monitored to detect a leak or obstruction in a sampling hole.
- The sampling pipes and fittings shall have mechanical strength and be listed for the temperatures and environmental conditions where they are being installed. See the Installation, Commissioning, and Maintenance Section of this Application Guide (page 13), for additional information concerning the requirements for sampling pipe installation.

The ASD system requirements outlined by NFPA are prescriptive in nature and provide specific sampling hole spacing distances and ASD unit sensitivities for each type of system (SFD, EWFD, and VEWFD). However, EN 54-20 is performance-based and requires ASD systems to pass a series of Test Fires (TF) to validate the classification of a Class A, Class B, or Class C system.

ASD systems provide a high level of design flexibility and can be installed in a wide range of applications; as a result, it is not possible to create specific design criteria and to conduct specific tests for each specialised application. With this in mind, three classes are defined to enable system designers and installers to select the most appropriate ASD sensitivity. Table 2 provides a summary of the various detector classes and the corresponding fire tests used for the classification.

EN54-20 defines sensitivity Classes and the requirements for each: Class A, Class B, and Class C:

- Class A – Very High Sensitivity – An ASD system with very high sensitivity capable of providing very early warning of a potential fire condition. This system would be particularly applicable for mission critical areas where fire damage could cause significant life safety issues, extended equipment downtime, or financial hardship. Class A is also ideal for detecting the presence of smoke in air conditioning ducts, which may originate from equipment within a clean room
- Class B – Enhanced Sensitivity – An ASD system with enhanced sensitivity capable of providing an early warning of a potential of a fire condition. This system would be particularly applicable for high-risk areas where additional protection is required; for example, within the proximity of valuable, vulnerable, or critical items, such as computers or electronic equipment cabinets
- Class C – Normal Sensitivity – An ASD system designed to give the equivalent performance of a standard point detection system

Table 2 – EN54-20 Classification table for aspirating smoke detectors*

Class	Description	Example application(s)	Requirement
A	Aspirating smoke detector providing very high sensitivity	Very early detection: the detection of very dilute smoke that could emanate from equipment in an environmentally controlled area and enter air conditioning ducts	Passes test fires TF2A, TF3A, TF4 and TF5A.

B	Aspirating smoke detector providing enhanced sensitivity	Early detection: for example, special fire detection within or close to particularly valuable, vulnerable, or critical items such as computer or electronic equipment cabinets.	Passes test fires TF2B, TF3B, TF4 and TF5B.
C	Aspirating smoke detector providing normal sensitivity	Standard detection: general fire detection in normal rooms or spaces, giving for example, at least an equivalent level of detection as a point or beam type smoke detection system.	Passes test fires TF2, TF3, TF4 and TF5.

*For the specific test fire performance parameters refer to the Annex of EN 54-20.

To measure the response thresholds of an ASD unit, it is essential to generate smoke particulate in a controlled manner. This subjects the detector to sampled air with a gradually increasing smoke particulate concentration, and obtains a known concentration of smoke particles compared to the overall quantity of sampled air.

EN 54-20 developed a series of test fires that allow smoke particulates to be consistently increased and measured. Table 3 below outlines the basic information concerning the test fires and the end-of-test conditions that are required.

The ASD unit's alarm signal shall be monitored so the ASD's response time for each test can be recorded along with the fire parameters.

Table 3 – EN 54-20 Test Fire Requirements

Test Fire	EN54-20 Location	Test Fire Description	End of Test Condition (EOT)(dB m ⁻¹ = Smoke Density -Optical)
TF2	Annex B	Smouldering (pyrolysis) wood fire	2 dB m ⁻¹
TF2A	Annex C	Reduced smouldering (pyrolysis) wood fires	Class A - 0,05 dB m ⁻¹
TF2B	Annex C		Class B - 0,15 dB m ⁻¹
TF3	Annex D	Glowing smouldering cotton fire	2 dB m ⁻¹
TF3A	Annex E	Reduced glowing smouldering cotton fire	Class A - 0,05 dB m ⁻¹
TF3B	Annex E		Class B - 0,15 dB m ⁻¹
TF4	Annex F	Flaming plastics (polyurethane) fire	1,73 dB m ⁻¹
TF5	Annex G	Flaming liquid (n-heptane) fire	1,24 dB m ⁻¹
TF5A	Annex H	Reduced flaming liquid (n-heptane) fire	Class A - 0,1 dB m ⁻¹
TF5B	Annex H		Class B - 0,3 dB m ⁻¹

The ASD shall generate an alarm signal in each test fire: before the specified time and after the specified end of test condition is reached.

To further confirm the ASD system design, the FIA provides a system performance test matrix outlined in Table 4 below. These tests can be used to confirm the ASD has been designed and installed to perform in accordance with the required codes.

Table 4 – FIA performance test to confirm system design

Type	Application	Response Class Ab	Response Class Bb	Response Class Cb
Primary	Clean room, Telco or computer facility (ceiling <3 m)	2 m PVC wire	1 m PVC wire	7-9 g pellet
	Other (in open areas high ceiling)	1 m PVC wire	7-9 g pellet	13-18 g pellet
Secondary	Low ceiling (<3 m)	2 m PVC wire	1 m PVC wire	7-9 g pellet Paper Chimney Poly'mat Pot'Lactose
	Normal ceiling (up to 20 m unless other stated)	7-9 g pellets	13-18 g pellets Paper Chimney – 5 m max.	2x13-18 g pellets Paper Bin Poly'mat Pot'Lactose
	High ceilings (>20 m)	N/A	2x13-18 g pellets	Paper Bin Pot'Lactose
Localized	Ideally devise custom test to reflect risk - otherwise use	2 m PVC wire	1 m PVC wire	7-9 g pellet Poly'mat Pot'Lactose
In-Cabinet	Vented/cooled	2x12 ohm for 80 secs..	2 m PVC wire	1 m PVC wire
	Un-vented > 3 m ³	12 ohms for 70 secs..	2x12 ohms for 80 secs..	2 m PVC wire
	Un-vented <3 m ³	12 ohms for 80 secs..	12 ohms for 70 secs..	2x12 ohm for 80 secs..
Duct	For smoke generated in the Duct	2 m PVC wire	1 m PVC wire	7-9 g pellet
	For smoke generated in the room, devised custom test to reflect volume and usage of space protected	1 m PVC wire	7-9 g pellet	13-18 g pellet

^bThe information for the performance tests are outlined in Appendix B, Appendix C, Appendix E, Appendix F, Appendix G, Appendix H of the FIA-COP

United States Definitions and Requirements

Within the USA, NFPA 76 "Fire Protection of Telecommunication Facilities" provides the following definitions:

Very Early Warning Fire Detection (VEWFD) Systems:

Systems that detect low-energy fires, before the fire conditions threaten telecommunications service.

Early Warning Fire Detection (EWFD) System:

Systems that use smoke, heat, or flame detectors to detect fires before high heat conditions threaten human life or cause significant damage to telecommunications service.

Standard Fire Detection (SFD) System:

Systems that use fire detection-initiating devices to achieve certain life safety and property protection, in accordance with applicable standards.

Table 1 – NFPA code requirements

NFPA (72 and 76) Requirements				
System	Alert Sensitivity (at each sampling hole) ^a	Alarm Sensitivity (at each sampling hole) ^a	Sampling Point Coverage Area	Transport Time
VEWFD	0.2% obs/ft..	1.0% obs/ft..	200 ft.. ² (18.6 m ²)	<60 secs..
EWFD	N/A	1.5% obs/ft..	400 ft.. ² (37.2 m ²)	< 90 secs..
SFD	N/A	No greater than spot smoke detector	900 ft.. ² (83.6 m ²)	< 120 secs..

^aThe maximum sensitivity of the individual hole as noted on the design software calculations.

Requirements of SFD systems according to NFPA 72

The requirements for the ASD System are outlined in the Initiating Devices Section of NFPA 72, and require that each sampling hole be the equivalent to a spot-type smoke detector for the purpose of location and spacing.

A traditional spot-type smoke detection system is spaced at 30 ft. (9.1 m), on centers, or each detector could protect 900 ft..² (274.3 m²). Therefore, the ASD sampling holes would be spaced in the same configuration.

- The maximum transport time for a SFD system, from the most remote sampling hole to the ASD, cannot exceed 120 seconds
- The transport times and system performance are required to be calculated by design software and confirmed during the commissioning process
- The ASD unit shall provide a trouble signal if the airflow is outside the manufacturer's specified range

Requirements of EWFD systems according to NFPA 76

When standard fire protection and detector spacing won't suffice, NFPA 76 outlines the requirements for more sensitive smoke detection systems that provide early warning to the presence of smoke.

The code classifies two levels of smoke detection systems: Early Warning Fire Detection (EWFD) and Very Early Warning Fire Detection (VEWFD).

The following are installation requirements for EWFD ASD systems, as outlined in NFPA 76:

- The coverage area for a single sampling hole is limited to 400 ft..² (37.2 m²).
- The minimum alarm sensitivity for a single sampling hole is required to be a maximum of 1.5% obs/ft..
- The maximum transport time is 90 seconds.

Requirements of VEWFD systems according to NFPA 76

When more sensitive detection is necessary, NFPA 76 outlines the installation requirements of these systems. The following are requirements for VEWFD ASD systems, as outlined in NFPA 76.

- The coverage area for a single sampling hole is limited to 200 ft..² (18.6 m²)
- The minimum alert sensitivities for a single sampling hole is required to be a maximum of 0.2% obs/ft..
- The minimum alarm sensitivity for a single sampling hole is required to be a maximum of 1.0% obs/ft..
- The maximum transport time is 60 seconds
- Where two levels of detection is required, high and low, sampling holes are required in the following locations:
 1. Each level of protection is required to have a maximum of 400 ft..² (37.2 m²) per sampling hole.
 2. The overall coverage between high and low sampling holes is required to be a maximum of 200 ft..² (18.6 m²).
 3. The maximum transport time is 60 seconds.

Section 2

Principles of Aspirating Smoke Detection (Airflow Dynamics)

The basic ASD system has three main components (Figure 1 below):

- The sampling pipe network, which collects air through sampling holes and transports it from the protected space to the detector, where it's tested for the presence of smoke particulate
- An aspirating smoke detector constituted of:
 - A sensing chamber with a high sensitivity sensor to detect smoke particles suspended in air
 - An aspirator or fan to draw air from the protected area to the sensing chamber
 - An optional filter to remove all large particles that may damage the sensor within the sensing chamber
- The exhaust pipe to expel the sampled air from the detector.

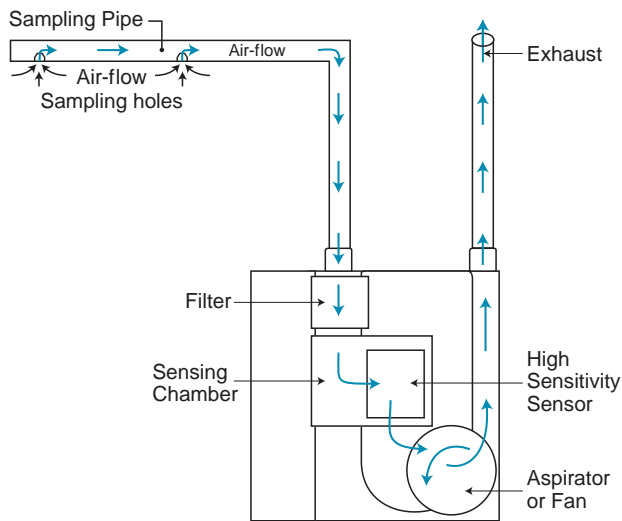

Figure 1. Basic aspirating smoke detection system
The blue arrows illustrate the air flow from the time it enters the sampling pipe to the point it is exhausted out of the ASD.

Sampling Pipe Network

The sampling pipe network is connected to a port on the top or bottom of the detector. It's typically constructed of plastic, but can be made of copper, brass, or another non-ferrous metal. Individual manufacturers have specific requirements for sampling pipes. The type of pipe is determined by the specific application and specified in the design software.

There are several methods of installing a sampling pipe network:

- **Single pipe configuration** (Figure 2 to the right), with one pipe connected to the detector and extending through the entire covered space. Selecting this configuration may result in longer pipe runs and delay sampled air collection at the detector.
- **Multiple pipe configuration** (Figure 3 bottom right), composed of multiple or branched pipes.

The sampling pipe can be installed horizontally at ceiling level, in-racks, or vertically for warehouse and atrium applications (Figure 4 on the following page).

For concealed locations, the sampling pipe can be hidden in a void space with smaller capillary tubes to sample the space (Figure 5 on the following page).

The piping network contains sampling holes that allow the air to enter the pipe. The sampling-hole spacing is determined by the type of detection system being installed, which is highly dependent on the type of application (e.g., warehouse, data centre, historic buildings). The individual sampling holes are sized according the design software, which considers the fluid dynamics of ASD systems and the type of design criteria of the detection system (discussed in later sections of this application guide).

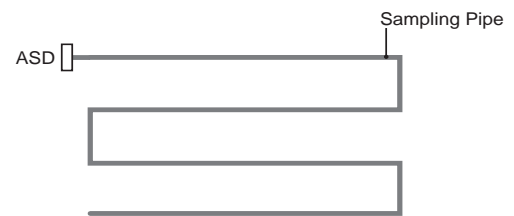

Single pipe system

Figure 2. Single pipe configuration for an ASD sampling pipe network



Two pipe system



Three pipe system

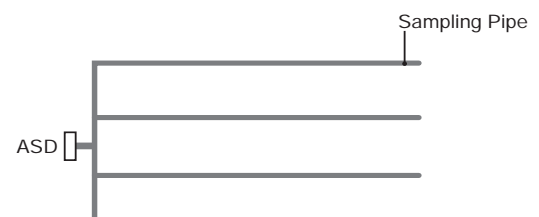

Four pipe system

Figure 3. Multiple pipe configurations for an ASD sampling pipe network

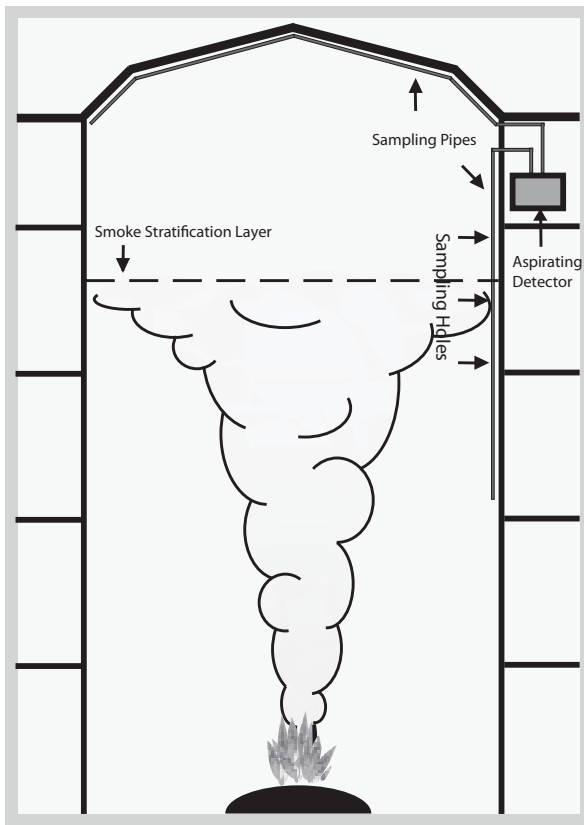

Figure 4. Vertical configuration for an ASD sampling pipe network

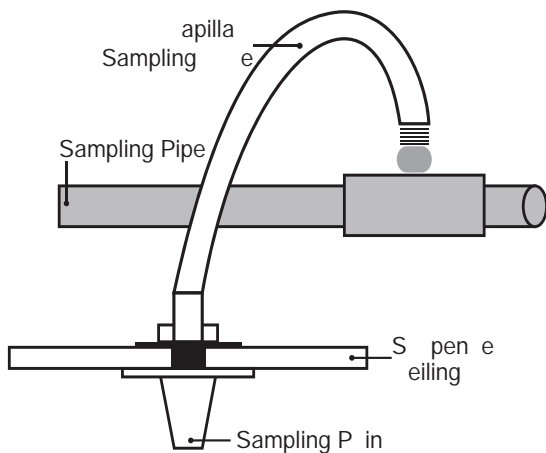

Figure 5. Capillary used for an ASD sampling pipe network

Aspirating Smoke Detector

All ASD systems contain similar equipment, but the detector technology type varies. Currently, there are several types of detection technologies:

Laser-Based Systems (Filtered) – This method utilises a laser as the light source within the detection chamber. First, the air passes through a filter system to remove all large particles. The filtered air sample then passes in front of the laser, and the light scatter caused by the smoke particulates is measured by a photo collector. The detector's sophisticated electronics determine the quantity of smoke particles within the chamber.

Laser-Based Systems (Non-Filtered) – This method, commonly referred to as "Particle Counting," also utilises a laser as a light source in the

detection chamber. However, in this configuration, the air is sent directly to the sensing chamber instead of passing through a filter. As the air passes in front of the laser, a photo collector counts the number of particles within the specified micron size to determine if sufficient smoke particulates are present. The laser technology's sophisticated electronics differentiate between suspended dust particles and smoke particles within the sample.

Cloud Chamber – This method is the oldest and original aspirating technology. The sensing element is a sealed chamber containing extremely dense water vapour. When a charged smoke particle interacts with the dense water vapour, the particle is ionized. The resulting ions act as condensation nuclei around which a mist will form (because the original water vapour is extremely dense and on the verge of condensation).

This process amplifies the size of the particulate from something that was below the wavelength of light (invisible) to a size far above the wavelength of light (visible). The particulate will then be sufficiently sized and the photo cell inside the chamber will detect the mist/smoke particulates.

Dual Source Sensor – This method utilises a blue LED to detect extremely low concentrations of smoke and an Infrared laser to identify nuisances like dust that can cause false alarms. Advanced algorithms interpret signals from both sources to determine if the sample is smoke or dust suspended in the air. Detected particulate levels could be as low as 0.0015%/ m (0.00046%/ ft.) obscuration.

ASD Exhaust Principles

In normal applications, it is common for the air pressure in the Air Pressure Protected Space (APS) to be the same as the air pressure in the space where the ASD is mounted, and the exhaust pipe is run out of the detector Air Pressure Exhaust Space (AES). As a result, the design software that calculates transport times and detector sensitivities assumes the air pressures of the two spaces are equal.

The sampling hole size, pipe size, transport time, and the fan aspirator speed are all functions of the air volume that passes through the sampling chamber. The sensing chamber is designed to detect smoke particles moving through the chamber at the speed of the fan. If APS is greater than AES, the velocities of the sampled air entering the chamber may be higher than the nominal fan speed, which could directly impact the detector's ability to sense smoke particles.

IMPORTANT: If AES is greater than APS, then air pressure is pushing on the exhaust air and causing resistance and a drag on the fan. As a result, the fan may rotate slower than designed, causing an increase in transport times and a decrease of air into the sensing chamber.

Please note: To eliminate the pressure difference, the exhaust air needs to be piped into the same room that is being sampled. (Figure 6 on the following page).

A pipe can be connected to the exhaust port to divert the exhaust away from the location of the unit; for example to exhaust back into the area to reduce noise, reduce risk of interference/deliberate obstruction, or to improve environmental protection etc.

Pipe of the same specification as the sample runs should be used. Care should be taken to position the new exhaust outlet where it cannot be accidentally or deliberately blocked.

ASD Sampling Methods

For the purpose of this guide, there are five acceptable sampling methods for all potential applications.

Primary Sampling

The name of this sampling method is misleading; it is typically a supplemental system and not the primary detection system. Primary sampling is configured to sample the air from a specific location or where the air is most likely to travel. For areas that have high airflow, such as data centres or clean rooms, the primary sampling location would be at return air grilles, air handling unit (AHUs), or air return ducts.

Secondary Sampling

This method involves configuring the sampling holes at the ceiling level, in similar locations as traditional spot-type smoke detectors. The sampling holes would be spaced in accordance with the appropriate code or standard.

Localised Sampling

This method involves protecting specific equipment/areas within a larger open space. Localised sampling may be used in a rack sampling system in a large open warehouse.

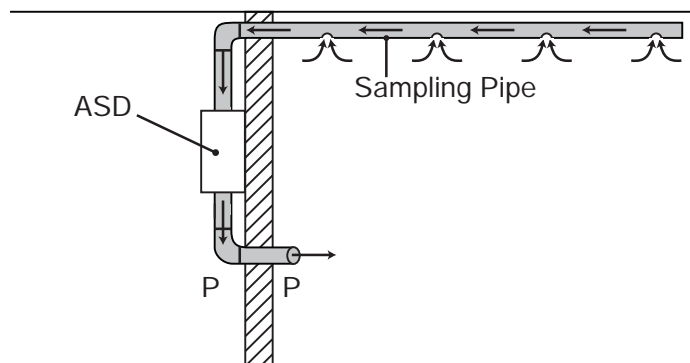

Figure 6. ASD Exhaust – AES vs APS
[in figure update labels in image (PE=AES and PR=APS)]

In-Cabinet Sampling

For this type of sampling method, the air sampling holes are installed to monitor specific pieces of equipment within a larger open space. This method is different from Localised Sampling because the protected volume is much smaller, and the piece of equipment is typically self-contained within a cabinet or computer rack. The ASD monitors the air used for equipment cooling. This type of sampling is typically installed on critical equipment that would cause devastating results if damaged by a fire.

In-Duct Sampling

This type of sampling uses an ASD, in place of traditional duct-mounted smoke detectors, to shut down the associated HVAC unit or close dampers to prevent the spread of smoke in the case of a fire. It can also be used to detect smoke particles being exhausted (or supplied), when a more sensitive detector is necessary.

Considerations for ASD Systems Based on Their Operating Principles

The Dilution Effect

An aspirating detection system's sensitivity is dependent on two main factors: the number of sampling holes drilled in the piping network and the programmable smoke detection thresholds.

The number of sampling holes can affect the dilution of the air returning to the sensing chamber. For example, when smoke is drawn into a single sample hole, it results in a dilution of the smoke concentration as it is transported through the piping network past other sampling holes that are aspirating clean air (no smoke concentration). When this volume of clean air is mixed with the smoke laden air being transported into the detection chamber, the quantity of smoke-laden air is diluted. This is often referred to as the dilution effect (Figure 7 below).

In Figure 7 below, the grey represents smoke entering a single sampling hole at the most remote location within the pipe. The smoke combines with clear air when it is transported through the pipe, diluting the smoke density. The dilution effect is directly linked to the sampling hole quantity within the pipe network. The more sampling holes, the greater volume of air being transported to the ASD, which results in an increased dilution of the smoke suspended in the air. For example, if there is a sampling pipe measuring 50 m (164 ft.) and it has sampling holes every 5 m (16 ft.), giving 10 sampling holes including the end cap.

It can be assumed in this simplified case that the sampling holes let in approximately the same amount of air as each other. A smoke source of 2% obs/m is introduced at the far end of the pipe. No other smoke is entering any of the other sampling holes. As the smoke passes each hole, it is added to with clean air. When the sample reaches the detector it is now at 0.2% obs/m or 1/10th of its starting density. Therefore, if the first alarm threshold is set at 0.2% obs/m, the smoke outside the hole must exceed 2% obs/m to sound the alarm. It is the case, therefore, that the longer the pipe and the greater the number of sampling holes, the more susceptible the system will be to dilution. It is wise to work on a worst case principle in these situations. In actuality the calculation of dilution is not as straightforward as above and more factors are involved. Each system will have different characteristics, meaning precise calculation is extremely complicated. Issues that will affect the dilution rate include size and number of holes, T-joints and bend/elbow joints in the pipe system, diameter of the pipe itself, and outside elements such as air temperature, pressure and humidity etc.

Transport Time

The transport time is defined as the time it takes for the smoke particulates to reach the sensing chamber. The time is measured (in seconds) from when the particulates enter the sampling point to the time they reach the sensing chamber. The times are calculated utilising the ASD's design software and field verified during the system commissioning process.

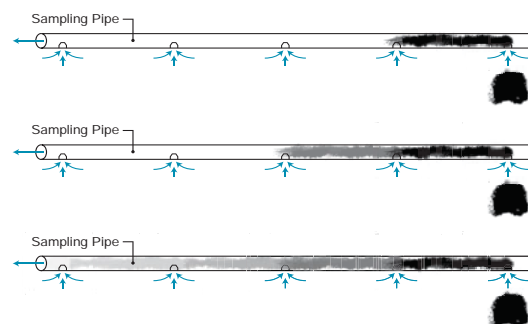

Figure 7. The Dilution Effect

Several parameters should be taken into account when discussing potential transport times:

- The size and number of sampling holes
- The aspirator speed setting (rpm)
- The sensitivity setting of the detector
- The total quantity and configuration of the sampling pipe

Modern codes and standards require specific transport times for different classes of ASD systems. The maximum required transport times for ASD systems can range from 60 seconds for Very Early Warning Fire Detection systems, 90 seconds for Early Warning Fire Detection systems, or 120 seconds for Standard Fire Detection systems. Refer to EN 54-20, NFPA 72, NFPA 76 and local codes of practice for the required transport times.

Benefits for ASD Systems Based on Their Operating Principles

Active Detection System

The ASD system is considered an ACTIVE form of detection because the aspirator continuously draws air from the protected area into the sensing chamber. This process is continuous and does not stop unless the ASD is shut down. The active nature of the ASD provides for the earliest possible detection of the presence of smoke, thus why ASD systems are often referred to as Early Warning Fire Detection Systems.

The extremely sensitive ASD sensing chambers are another significant aspect of the active smoke detection system because they can detect smoke in a fire's incipient stage long before incurring damage to the protected space and equipment.

The Additive Effect

The ASD system overcomes dilution by the additive effect that is common to ASD systems. The additive effect is a significant benefit of ASD technology, which results in an extremely sensitive detection system, even when multiple sampling holes are present.

During the detection process, air is drawn into all sampling holes in the piping network, which allows each hole to contribute to the total air sample within the sensing chamber. As explained earlier, this is the total volume of air within the detector's sensing chamber: the more sampling holes, the greater the volume of air. If multiple sampling holes are aspirating smoke-laden air, then the smoke particles are combined as they are transported back to the sensing chamber. The ratio of clean air to smoke laden air is decreased. It is this additive effect that makes the overall detection system more sensitive than a traditional, spot-type smoke detection system.

Assuming the ASD's Fire Level 1 sensitivity is set at 0.25% obs/ft. (0.25 %/ft.), the ASD system is protecting a room that is 1,219.2 m² (4,000 ft.²) and the system is designed with the sampling holes spaced at 6 m/hole (20 ft./hole) (36m² of 400 ft.² per hole), the resulting detection system would contain 10 sampling holes. The 0.25%/ft. is the sensitivity of the detector's sensing chamber.

To determine the actual sensitivity of the individual sampling hole, multiply the programmed detector obscuration rate by the total number of sampling holes in the piping network.

For example, the detector sensitivity for Fire Level 1 set at 0.25%/ft. with 10 holes drilled in the piping network would correspond to an individual sampling hole sensitivity of 2.5%/ft. (0.25%/ft. multiplied by 10 = 2.5%/ft.).

The sensitivity is similar to the obscuration rate of a traditional spot-type smoke detector. This represents the effective sensitivity of the detector if smoke enters a single sampling hole (Figure 8 below).

The benefit of the ASD system is its active nature to draw air into all sampling holes simultaneously; the air is combined in the pipe and transported back to the detector for sampling. When air is drawn into all 10 sampling holes, the smoke particle concentration increases and the clean air concentration decreases. As the smoke particles are added together, the overall detection system sensitivity is increased.

To explain the additive effect further, take the same 1,219.2 m² (4,000 ft.²) room with an ASD piping network with 10 sampling holes and smoke particles being drawn into two sampling holes (Figure 8 below).

To determine the new individual hole sensitivity, the obscuration rating for Fire Level 1 (0.25%/ft.) is multiplied by the total number of sampling holes (10), then divided by number of holes detecting smoke (2). This results in a new effective sampling hole sensitivity of 1.25%/ft., making the ASD system twice as sensitive as a spot smoke detector at 2.5%/ft..

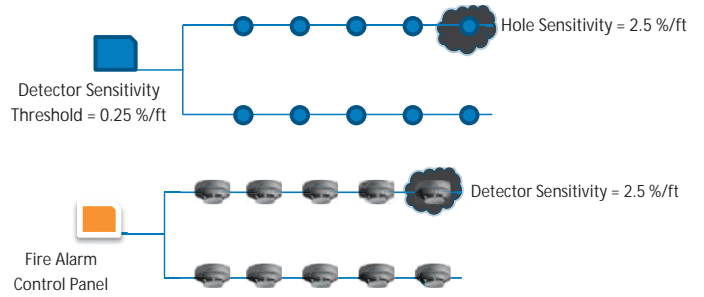

Figure 8. Comparison (ASD – point smoke detector) with smoke reaching a single sampling hole or a spot point smoke detector

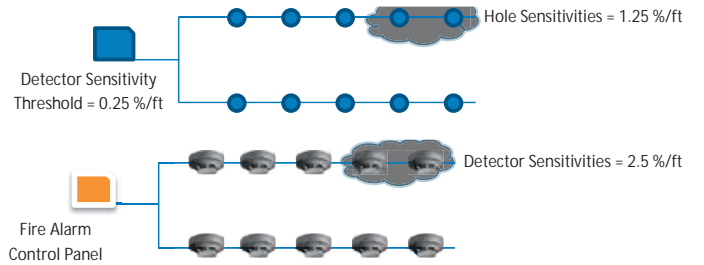

Figure 9. Comparison (ASD – point smoke detector) with smoke reaching two sampling holes or two spot smoke detectors

If smoke enters three sampling holes the effective sensitivity is 0.83 %/ft., and so on.

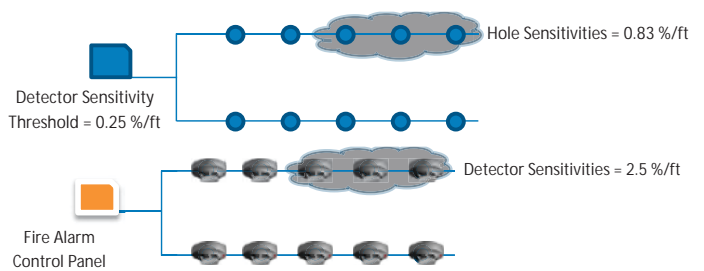

Figure 10. Comparison (ASD – point smoke detector) with smoke reaching three sampling holes or three spot smoke detectors

To further explain the additive effect, this example can be expanded to include smoke entering all 10 sampling holes. Each sampling hole would have an individual sensitivity of 0.25%/ft., making the ASD system 10 times more sensitive than spot smoke detectors at 2.5%/ft. (Figure 10 on the previous page).

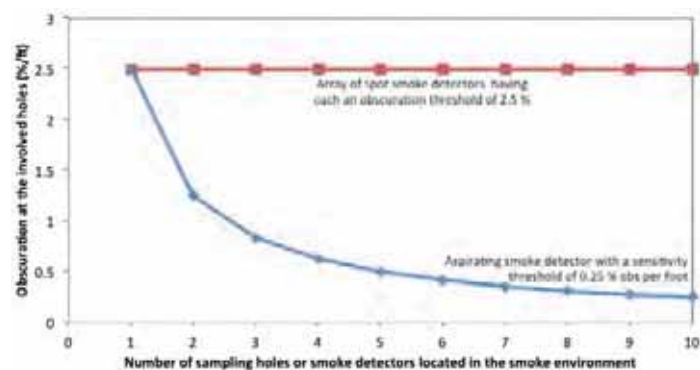

Figure 11. Additive property of the ASD system

Low Sensitivity Thresholds

Another significant ASD benefit is the sophisticated electronics that detect smoke particles at much lower obscuration rates and at multiple sensitivity levels. These detection thresholds are programmable and allow end-users the flexibility to create an extremely sensitive smoke detection system for environments and occupancies that require very early smoke detection for life safety and business continuity or less sensitive for environments that are less critical in nature. The typical ASD system thresholds are UL-listed for sensitivities ranging between 0.00046%/ft. (for the facilities where early smoke detection is critical) and 6.25%/ft. (for environments that are not as critical). An aspirating smoke detection system programmed to detect smoke particles at the lowest possible UL listing of 0.00046%/ft. would be over 1,000 times more sensitive than traditional spot-type smoke detection systems.

Aspirating Smoke Detection Benefits for Diverse Applications

When it is critical to detect smoke at the incipient stage of a fire, ASD systems have many benefits.

Early Levels of Detection

ASD systems' ability to detect smoke particles at much lower obscuration levels make them ideal for areas that require the earliest possible smoke detection (before combustion and damage can occur). Typical applications include museums, historically significant buildings, culturally significant hazards, and mission-critical facilities such as data centres. Also, the programmable sensitivity ranges allow the ASD system to be customised to the individual hazard being protected, which provides the owner a greater level of flexibility.

Reliable Detection

The ASD system's detection software allows the sensing chamber to differentiate between smoke particles and dust particles that may be suspended in the sampled air. This technology makes the ASD resistant to nuisance alarms and eliminates unwanted alarms that could cause unnecessary equipment shut-down, facility downtime, or premature building evacuation.

Unaffected By High Airflows

High-airflow rooms, such as data centres, telecommunication centres, and clean rooms, present a common hazard. The high airflow produces air changes within the area and dilutes smoke, making it more difficult to detect.

The high air velocity carries the smoke particles away from the traditional ceiling-mounted, spot-type smoke detectors and to the HVAC units for conditioning. Larger particulates are filtered through the HVAC unit, but small particulates pass through the filter and back into the room. The smoke particles then become part of the ambient air, but they can be detected because the ASD is actively sampling the air within the protected space.

No Degradation of Aesthetics and Actions Related to Tampering

Another benefit of ASD systems is the ability to conceal the sampling pipe and remotely install the detector, which makes them suitable in environments where tampering is a concern (such as correctional facilities or schools). They're also ideal for areas where aesthetics are a concern (i.e., historic or culturally significant spaces).

Usage in Harsh Environments

In harsh or dirty environments, large particles can damage traditional detectors' electronics and small particles can initiate nuisance alarms. The ASD system samples air from the protected space and filters potentially damaging particles, making it ideal for installation in such environments. Also, the detector is located outside the protected space, which makes ASD systems suitable for areas that have extreme temperatures (such as coolers and freezers).

Easy Maintenance

After the ASD and sampling pipe is installed, the transport times and sampling pipe pressures need to be documented. Then, the yearly maintenance consists of testing the most remote sampling holes and comparing the transport time to the commissioning documents. When sampling pipe is installed in a high ceiling or concealed in a sub-floor, a test sampling point can be installed at floor level to make annual testing of the system easier and reduce annual maintenance costs.

Any pipe network designed to be used with FAAST must be verified using PipeIQ software.

System Design

When designing the actual sampling pipe network there are many factors that need to be considered. The site must be carefully surveyed and as much information as possible should be gathered.

Requirements

The first consideration is to precisely ascertain the requirements of the installation. Once these have been decided, the type of situation can be looked at.

Activities

The types of activities that take place within the space are very important. A public area of a particular shape could have different system requirements to a warehouse of a similar shape. Other information such as the expected hours of operation, whether the area is manned or unmanned and whether any pollution or dirty air is present, should also be taken into account.

Physical Characteristics

Once the general installation type has been considered, the physical characteristics of the space should be looked at:

- Is it a room, void, cabinet or enclosure?
- Are there any floor or ceiling voids and if so, how are they divided?
- Are there any ducts and if so, what are they used for and are there any services already present?
- What are the exact measurements of the space?
- What materials have been used and are there any areas where the network should avoid?
- Are there any existing fire protection systems and if so, where are they situated?

Environmental Conditions

The environment within the space can have a very significant bearing on the sampling method that should be used to protect it.

As already mentioned, smoke tests are vital in gathering this information. This can tell you the patterns of air movement, the rate of circulation and whether the airflow is static at any point.

Other considerations include:

- If fresh air is introduced, at what rate and in what quantity?
- Is a reference detector necessary due to pollution?
- What is the temperature and relative humidity and are these constant or variable?
- Are there any activities that may produce smoke, dust, steam or flames and how often do such activities occur?

Risk Assessment

With any installation it is likely that some areas require more protection than others. This could be because of expensive equipment or a particularly vulnerable area such as a store for flammable materials. These more susceptible areas must be considered along with any structural hazards, such as synthetic materials and foams or soft wood partitioning.

Potential Sites

There are also factors to consider when deciding where to position the detector unit itself. The main aim when positioning the unit is to try to ensure a balanced system. This means that the pipes should be kept at similar lengths. It is also important to try and keep response times and dilution to a minimum.

The unit requires a power supply and access will be required for maintenance. There may also be aesthetic reasons why a particular position is not suitable.

Exhaust Pipe

The exhaust pipe of the aspirating detector unit can have piping added, should it be required; for example if the air passing through the detector needs to be returned to its source. Extra piping can also be used to reduce the noise of the fan, if needed.

Section 3

Installation, Commissioning and Maintenance

Installation

This section provides the basics for ASD pipe network installation. The ASD system is required to be installed in accordance with not only EN 54-20, but also with BS 5839, BS 6266 and/or FIA Code of Practice for the Design, Installation, Commissioning & Maintenance of Aspirating Smoke Detector (ASD) Systems. Prior to starting the installation, the installer needs to remember that each system has its own characteristics and variations to accommodate the ASD piping and ensure proper system operation.

ASD pipes can vary from plastic to non-ferrous metal, such as copper. The most common pipe in the industry is 25 mm OD (0.75 in.), CPVC, PVC, ABS, or UPVC pipe. However, the internal pipe diameter can vary between 15 mm - 21 mm (0.591 in. - 0.827 in.), depending on system design requirements and local codes and regulations. ABS is the most commonly installed pipe material in Europe and CPVC is the most commonly installed pipe material in the United States. The most common installation materials, fittings, mounting brackets, hangers, and installation methods are described in the following sections.

Pipe Requirement

For EN54-20 compliance, the pipe should be Red ABS to EN 61386 (Crush 1, Impact 1, Temp 31), with a nominal outside diameter of 25 mm (internal diameter 21 mm). The pipe sections should be glued together using a suitable ABS glue to avoid separation or leaks. If a section of pipe is likely to need to be disconnected for some reason in the future, removable unions should be used instead.

IMPORTANT

Ensure that no hole is less than 100 mm from a bend or T-joint. Never glue pipes into the aspirating detector unit itself.

Fittings

Fittings connect sections of pipe for longer network runs; they are made from the same material as the pipe. There are several types of fittings to allow for various bends, straight runs, branches, and connections. Common fittings are described on this page.

Couplings and Unions

Couplings and unions are used to connect two sections of pipe in a straight line. A coupling is used when the section is not intended to be taken apart. A union offers the ability to screw the two pipe sections together for future access, which is useful for areas of the pipe network that have to be periodically disassembled for maintenance or cleaning. Unions can also be used to correctly orient sample holes in a specific section of the pipe network, such as over return air grilles. Figure 1 below shows a typical plastic union and coupling.

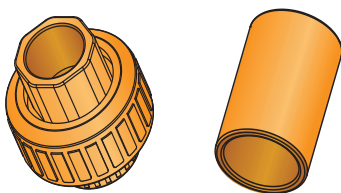

Figure 1. Typical Plastic Coupling and Union

Bends/Elbows

Bends/elbows are used to change the direction of the pipe network. Both 45° and 90° bends/elbows may be used. A typical bend is shown in Figure 2 below and typical plastic elbow fittings are shown in Figure 3 below.

Bends are either 45° or 90°. For the 90° bends it is very important that slow radii are used and not a sharp bend, as this will introduce unnecessary pressure losses, and increase the response times from holes beyond the bend. Ensure that no hole is less than 100 mm from a bend.



Figure 2. Typical plastic bend

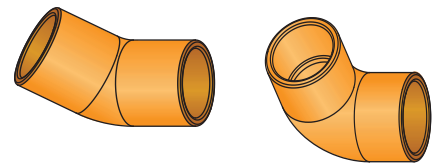

Figure 3. Typical Plastic 45° and 90° Elbows

T-Joint and End Caps

A T-joint can be used on pipes to produce multi-branches. It is important that the branches have a balanced design - that is, they should be approximately equal in length and number/size of holes). Ensure that no hole is less than 100 mm from a T-joint. They are used to attach drop tubes or sampling pipes in the network. A specialised T-joint can be used to attach a capillary tube and a sampling point as featured in Figure 4 below.

The end of the pipe should be terminated with an end cap, having a central hole to control air flow. If the end cap is not used, then practically no air will be drawn through the side holes. Without a hole in the end cap the contributions from the side holes will tend to be very unbalanced. For pipes with only a few sampling holes, the end cap hole usually is the same size as the sampling holes along the pipe. When there are more than five sampling holes, the end cap hole may be larger than the remaining sampling holes along the pipe. The end cap can be considered a sampling point if required.

The end cap may have a sampling hole: its presence and size are determined by the system design software - PipeIQ. Please see Figure 4 below.

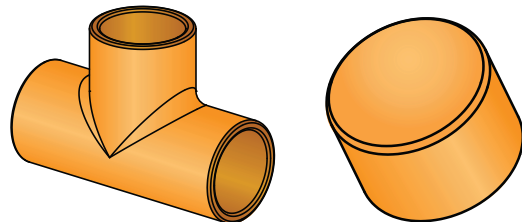

Figure 4. Typical Plastic T-Joint and End Cap

Capillaries and Sampling Holes

Capillary Sampling

A capillary tube is a length of flexible tubing connected to the main sampling pipe with a sampling hole at the end. The purpose of these tubes is to extend the sampled area away from the main pipe network.

Capillary tubes are used when sampling an enclosed space, such as a cabinet or a suspended ceiling, or when necessary or for aesthetic and security reasons. This hides the core pipe network and allows only a small sampling point in the space. Figure 5 below shows the capillary tube extending down from the main sampling pipe with a sampling hole located at the sampling location. Design software supports the addition of capillary tubes and sampling points to the pipe network design and calculates the appropriate air flow through the system. The typical maximum length for capillary flexible tubing is 8 m (26 ft.), but can vary depending upon the design software calculations. When multiple capillary tubes are used in a network, the length of each capillary tube should be approximately equal. This will allow for a balanced system.

Note 1: It is recommended to avoid running lengths of pipe with both standard sampling holes and capillary sampling points, as this can unbalance the airflow and slow the response time from the capillary points.



Figure 5. Capillary Sampling Point



Figure 6. Mounting Clips

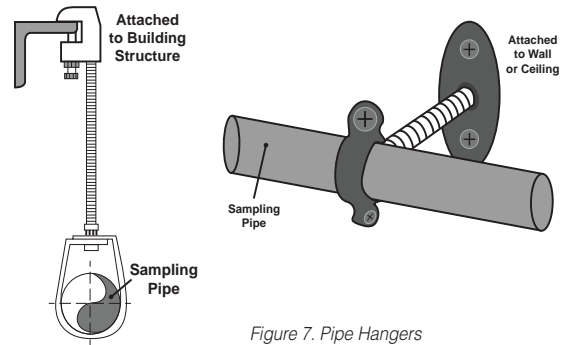

Figure 7. Pipe Hangers

Sampling Holes

Sampling holes can be located directly in the pipe, on an end cap, or in a sampling point at the end of a capillary tube. The most important factor is to properly drill the holes with a diameter conformed to the design software prescriptions.

The sampling holes should be drilled after the piping network has been installed. To prevent sampling holes from being blocked by dust and dirt, place the holes on the bottom side of the sampling pipes and not on the top of the pipe. This prevents any falling debris from clogging the sampling holes. The following guidelines should be followed when drilling the sample holes in the pipe network.

- Holes must be drilled perpendicular (90°) to the pipe. If the drill is not held perpendicular, then the hole is not round and may affect air flow
- Holes must be drilled exactly at the positions required by the design software
- Holes must be drilled with the exact size determined by the design software
- Holes must not be drilled through both sides of the pipe
- Holes should be drilled using a slow speed drill with a sharp drill bit. This minimises the risk of burrs as well as the possibility of dust and swarf entering the piping network
- After all holes are drilled, it is good practice to blow compressed air through the pipe to clear any dust, dirt, or debris from the pipe. A shop vacuum can also be used to draw the foreign material from the pipe by removing the end cap and using the vacuum to draw the debris through the end of the pipe near the detector connection. It is critical to remove the sampling pipe from the detector before compressed air is blown into the pipe or the shop vacuum is connected to the piping network, because small particles being blown into the sensing chamber could damage the components

Installation Materials and Pipe Hangers

Mounting Brackets/Hangers

The pipe network is mounted to the ceiling or a solid structural component using pipe mounting brackets shown in Figure 6 to the left. It can also be suspended from a slab ceiling with plain pipe clamps, clevis hangers, adjustable suspension clamps, C-clamps, and threaded rods. A large variety of brackets are also available, including clips, saddle clamps, or tie wraps, as shown in Figure 7 above. The mounting device will depend on the mounting material, environmental conditions, and local codes and regulations.

Spacing distance of sampling pipe hangers and supports are defined according to temperature and pipe diameter, as illustrated in Table 1 below. It is critical to install the support brackets and hangers at the required spacing so the pipe does not sag and create stress at the couplings, elbows, and unions, which could cause a crack or break in the pipe.

Table 1. Spacing distance of sampling pipe hangers and supports, with respect to temperature and pipe diameter

Pipe Diameter	Spacing distance of sampling pipe hangers and supports, with respect to temperature		
	21°C (70°F)	38°C (100°F)	60°C (140°F)
15 mm (½ in.)	1.3 m (4.5 ft.)	1.2 m (4 ft.)	0.7 m (2.5 ft.)
20 mm (¾ in.)	1.5 m (5 ft.)	1.2 m (4 ft.)	0.7 m (2.5 ft.)

Open-style mounting clips should not be used in an inverted position with the open section facing downward, as the pipe could accidentally drop from the clip. In applications when the sampling pipe is installed below the raised floor, the pipe can be mounted directly to the raised floor stanchions using wire ties, conduit clamps, or other installation device.

Pipe Labels

NFPA 72, FIA, and other recognised codes and standards require ASD pipes be labelled to distinguish them from other pipes and to specifically identify them as a fire detection system component. Both the sampling pipe network and each individual sample hole need to be identified. The pipe and sampling holes should be labelled at the following locations:

1. At changes in direction or branches of piping
2. At each side of penetrations of walls, floors, or other barriers
3. At intervals on piping that provide visibility within the space, but no greater than 61 m (20 ft.)
4. At each sampling hole.

The pipe shall be labelled with similar verbiage “SMOKE DETECTOR SAMPLING TUBE: DO NOT DISTURB.” See Figure 8 below for sampling hole and pipe labels.



Figure 8. Sampling pipe and sampling hole labels

Installing Sampling Pipe Network

For ceiling detection, the sampling pipe network should be mounted near the ceiling. To minimise the threaded rod length, the pipe network should be mounted 25 mm – 100 mm (1 in. - 4 in.) below the ceiling, subject to local codes and regulations. See Table 2 to the right for the typical installation steps for ASD pipe sampling systems.

Mounting the Pipe Network

Pipe mounting is the most time consuming part of the system installation process, and it can negatively impact the ASD system if it is not done properly. Consider the following recommendations when mounting the pipe network:

- Minimise pipe bending or sagging by bracing and supporting it at the required intervals, and install additional support at/near couplings and bends
- Avoid bending the pipe. Install a bend or reconfigure the sampling pipe if a slight change of direction is required
- Allow for pipe expansion and contraction in environments with extreme temperature changes, especially on long, straight sections of sampling pipe.

Cutting Pipe

Use proper tools when cutting pipe. Use shears or a wheel-type plastic tubing cutter for PVC, CPVC, or ABS pipe. Saws are not recommended because they can produce rough edges in the pipe. Use a tube cutter for copper or other thin-walled, non-ferrous metal piping. When cutting copper or other thin-walled metal piping, it is important not to crimp or bend the edges: this may cause air leaks at the couplings. Always keep the tools' cutting edges sharp and ensure cuts are made perpendicular to the pipe length, keeping the cuts square.

Square cuts ensure maximum bonding area and help provide a good seal when joining the components. Remove all loose material and any burrs from the end of the pipe after a cut – as well as debris and shavings from cuts – in order to keep sampling holes free of obstructions.

Joining Components

The sampling pipe network must be permanently connected once the system has been installed and tested. Establishing a permanent connection depends on the material of the pipe and fittings. For plastic pipes, it is important to use the proper type of glue. Never place solvent or glue on the inside of a pipe when gluing fittings and sampling pipe together; solvent can build up if applied to the inside of a pipe or other components. This build-up can cause obstructions that affect the air flow within the pipe network, and could cause abnormal behaviour within the sampling pipe. Solvents and glue should be applied only to the outside of the pipe being inserted into a coupling or other fitting. Make sure pipes are inserted completely and butted against the lip of the coupling or other fitting. The gaps can cause turbulence if this is not done, which can cause problems with the system pressure and air flow.

Table 2. Spacing distance of sampling pipe hangers and supports with respect to temperature and pipe diameter

Step	Action
1	Verify the design documents are accurate and obtain the size and configuration of the pipes in the sampling network
2	Mark off the area where the system is to be installed and identify the location where the ASD detector is to be mounted
3	Select and mark the locations for all pipe clips or pipe hangers in accordance with the design and manufacturer's recommendations

4	Install the ASD detector in the permanent location
5	Mount the pipe clips or pipe hangers according to the previously marked locations
6	Dry mount and assemble the pipe network according to the pipe network design documents. DO NOT permanently connect the pipes at this stage
7	Measure and mark the sampling holes on the pipe network. Make sure that the spacing of the sampling holes is in accordance with the network design and manufacturer's recommendations. Based upon the ASD system application, ensure that the sampling holes are at the correct orientation to the air flow, as recommended in the section on network pipe design
8	Verify the sampling holes' position and orientation and drill the sampling holes
9	Drill and install end caps on all appropriate pipe ends
10	Modify the design documents to agree with the actual network, if the physical network is significantly different from the original design documents
11	When testing is completed and the system performance is verified, permanently bond the pipe network together. CAUTION: Never glue the pipes to the ASD detector. The ASD detector inlet and outlet are tapered to accept the piping without any glue and provide an air tight seal
12	Label all portions of the system according to local codes and regulations, with available pipe and sampling point labels
13	If changes are made to the piping network during the installation process, the installing contractor is required to update the design documents to include new design software calculations and installation drawings. These documents will be needed during the Commissioning Testing



Figure 9. 3-Way valve for pipe cleaning

Maintenance Components

It is recommended to install an isolation ball valve and a T-joint fitting with an end cap on the sampling pipe, approximately 5 cm - 30 cm (6 in. - 1 ft.) from the ASD detector pipe inlet. This valve will be used during the reoccurring maintenance. This is particularly important for ASD systems protecting dirty areas or environments where frequent maintenance is required. See Figure 9 below left.

Commissioning

Commissioning the system is the final stage of the installation process. It ensures that design criteria are met for the sampling pipe network installation, and that the alarm levels and thresholds for the ASD system are correctly programmed for the considered installation site and application. The commission test should be documented on a Commissioning Report and given to the owner at the completion of the test.

Pre-commissioning is a set of tasks that should be performed before the Commission Test begins. In order to carry out these tasks, it is important to assemble the following list of documents and items:

- The ASD system design criteria; for example, was the system designed for standard fire detection, early warning fire detection or very early warning fire detection Class A, Class B, or Class C for installations in Europe?
- ASD programmed sensitivities, alarm thresholds and time delays
- The "as built" drawings showing the sampling pipe network
- The ASD computer-based design calculations
- Required local authorities' test report forms
- All materials and equipment necessary to complete the Commissioning Test (computer with design software to program/verify ASD settings, canned test smoke, a stop watch, a ladder, the proper Commissioning Report Form, and AHJ-required testing documentation).

Preparation for Testing

While on site (and before the actual commissioning process begins), the following items need to be verified to complete the test in accordance with the applicable code and manufacturer's recommendations.

- Check the electrical and signal cabling (if networked), of the ASD and the associated power supply(s). Refer to the manufacturer's installation, wiring, and cabling requirements for detailed and specific information
- Verify that the ASD detector(s) and the associated power supply(s) are monitored by the fire alarm system. Each ASD detector is required to be monitored for a minimum of alarm and detector trouble conditions. Each power supply is also required be monitored; due to the wide range of monitoring options, it is important to document the monitoring points
- Visually inspect the sampling pipe network to ensure the installation complies with the as-built drawings and to verify the pipe is supported properly
- Ensure the protected room or area is in its normal operational condition in terms of airflow, temperature, and cleanliness. This includes all normally operating air handlers and CRAC units. For areas that have suspended ceilings and raised floors, all tiles should be installed
- Ensure that all heat-producing equipment is running at the time of the test, including pieces containing an internal fan

Prior to the test, and in accordance with EN54-20, NFPA 72 and FIA Code of Practice, verify the building's fire alarm system is placed in testing mode and that all occupants are notified. This ensures that everyone is aware of the commissioning process so the test can be conducted efficiently. Typically, a two-person team performs the Commissioning Test of an ASD system, with one technician introducing canned smoke into the sampling hole and the other remaining at the detector location to acknowledge when smoke is detected. The results of the travel times are documented on the Commission Form.

Relay Function Testing

ASD system commissioning should include testing and verifying that all programmable relay outputs function as designed. However, as stated above, most ASD systems are monitored by the building fire alarm system or other entities: they are frequently programmed to initiate the building occupant notification system, shut down the air distribution system, or activate a suppression system via the relays. Before the commissioning test starts, it is critical that the owner is consulted and the design drawings are thoroughly reviewed, in order to disable any of these functions.

ASD Transport Time Testing

During the commissioning process, all sampling holes should be tested to establish the baseline used during annual testing. For the annual or routine maintenance testing, only a few holes need to be tested and compared to the original transport times on the Commissioning Report. Typically the sampling holes furthest from the ASD detector are tested. If the transport times remain close to the initial results, the system is operating as designed and no further testing is required.

If there is a difference of 5-10% between the transport times predicted by the design software and the tested transport times, then the piping network, hole sizes, or the detector settings should be checked to determine the causes of this difference; for example, if wrong sized sampling holes were drilled, if undocumented changes were made to the sampling pipe network without performing a design calculation, or if the ASD settings were not programmed properly. Any deviation should be immediately addressed and corrected by the installing contractor.

Documenting Test Results

All test results must be recorded in accordance with local codes and regulations, as well as within manufacturer's recommendations. At a minimum, the Commissioning Form should contain the following information:

- Type of detection system (SFD, EWFD, VEWFD, Class A, Class B, or Class C)
- Number of sampling pipes and sampling holes
- Hole size
- Testing results related to:
 - Transport times
- Signatures of all the persons attending the test (agents performing the test, customer/owner's representatives and authority representatives)

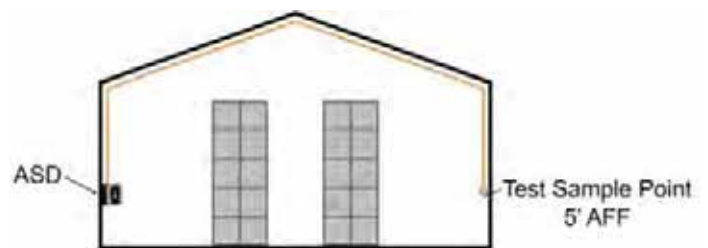

Figure 10. 3-Test sample point for warehouse installation

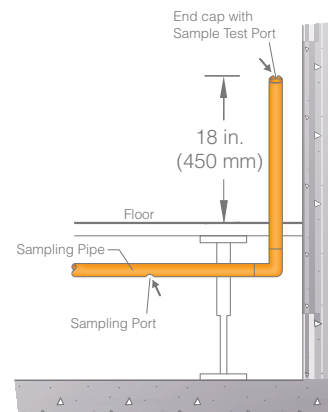

Figure 11. 3-Test sample point for void space or sub-floor

- Customer's information: name and address
- Date of the test
- Installing contractor's information, including name, address, and contact telephone number
- Identification of the rooms being protected
- Witnessing/approving authority information
- ASD information:
 - Detector serial number
 - Sensitivity
 - % obs/m (% obs/ft.)
 - Thresholds, with day, night, and weekend settings
 - Time delays

Customer Acceptance

Both the team performing the testing and the customer/owner's representatives should be completely satisfied with all the results from the commissioning tests. They should also agree that all testing results meet the local codes and regulations and manufacturer's recommendations for the type of system being tested, and that the testing results confirm the calculated hole and transport times calculated with the design software. The final acceptance of the tested ASD system should be a complete and signed copy of the Commissioning Form, a copy of the as-built drawings, and Owner's Manual.

Testing and Maintenance

ASD system testing is critical to ensure the system is operating as originally designed. The testing requirements are outlined in EN 54-20, BS 5839, BS 6266 and/or FIA Code of Practice for the Design, Installation, Commissioning & Maintenance of Aspirating Smoke Detector (ASD) Systems and the manufacturer's recommendations. Per the test methods documented in the manufacturer's published maintenance instructions, the ASD alarm response is allowed to be verified through the end sampling hole on each pipe run and the airflow through all other ports shall be verified as well.

For regular testing in areas that are difficult to reach, such as warehouses, void spaces, or sub-floors, a test sample point can be installed at the end of each sample pipe. (See Figure 1 and Figure 2 below). During the commissioning process, the transport time from the test sampling point should be documented; if the transport time is within 5-10% of the documented values during annual testing, the system can be assumed to be operating as originally designed.

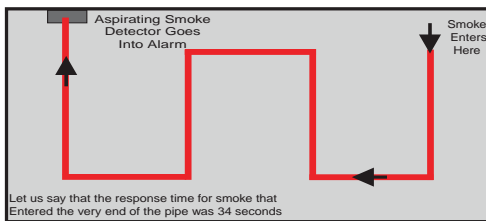

Figure 1. Single Sampling Pipe

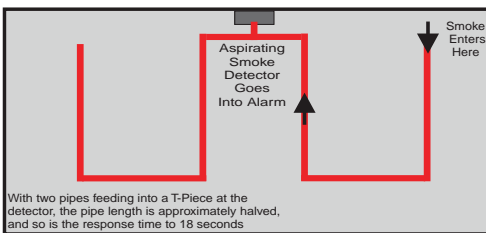

Figure 2. Two Sampling Pipe

Smoke Tests

IMPORTANT: It is strongly recommended that, before designing the pipe-work system, smoke tests be undertaken in order to show the patterns of air movement within the areas to be protected. This is particularly important in rooms with air-handling equipment. In all cases the aim must be to place the sampling pipes at the position the smoke is most likely to reach.

Smoke boxes or smoke matches can be used to establish air movement within the protected area, so the best place to locate the pipes can be identified, as well as sampling hole locations in the pipe.

If air handling equipment is present in the environment, consideration must be given to all the variable settings that are available; for example, if it is switched on or off, or if an air conditioning unit has a directional wave facility).

Sampling pipe network and holes

Sampling pipe network maintenance and sampling hole cleaning is recommended for all ASD system installations. Depending upon the environment in which the sampling pipes are installed, sampling holes should be cleaned every 1-2 years. More frequent maintenance may be

needed for environments with high amounts of airborne particulate or cold environments where condensation may freeze on the sampling hole.

To properly clean sampling holes, a technician can either use a pipe cleaner to clean each one or use compressed air/a vacuum on the piping network.

Before cleaning sampling pipes' holes, the technician should:

- Either place the connected detector in isolate or disable mode or power down the detector
- Disconnect the involved sampling pipe network from the detector, or at least close the valve on the T-joint fitting to ensure no air can be forced into or out of the detector. This is extremely important, and caution should be taken when performing this type of maintenance. Forcing air into or out of the ASD detector by any means other than the built-in fan may damage it and nullify its warranty

To perform the pipe network maintenance:

- The sampling pipe can be cleaned by using compressed air. Alternatively, a vacuum cleaner can be connected to either the end of the sampling pipe network or the T-joint fitting at the beginning of the pipe network
- While the vacuum is running, use a dry brush or pipe cleaner to swab out each sampling hole in the piping network. Leave the vacuum running for two minutes following the hole cleaning, to ensure all dust particles are removed from the pipe

After the pipe network maintenance, the technician should:

- Reconnect the cleaned sampling pipes to the ASD detector or open the valve on the T-joint fitting
- Replace the detector in operating mode, or re-apply power to the ASD detector
- Observe the air flow indication on the front of the ASD detector to ensure its fan is operating properly and the air flow has normalised. In the event of an air flow fault condition, the technician should perform another visual check of the sampling pipe network, to verify all connection points are sealed. If a pressure difference exists between the room being sampled and the room in which the ASD is located, then the technician should verify that the exhaust pipe is connected properly and that the sampled room is in the "normal" condition; for example, by verifying that all doors are closed and the HVAC units are running

ASD Detector

The only required maintenance for the ASD detector concerns the periodic replacement of its filter. Refer to individual manufacturer's instructions for filter replacement instructions.

Section 4

Troubleshooting Guide

Though ASD units are extremely reliable, they may occasionally have troubles that impair system operation. Most ASD units have trouble indicators on the face of the unit that help determine the cause of the fault.

Below is a list of common trouble indicators. Consult the manufacturer's installation and programming guide for a more specific list.

Fault Description	Cause	Recommended Action
Power Failure	No LEDs on the face of the ASD unit	Check the power supply for the ASD unit to determine if it is functioning properly. Verify the correct voltage is being provided at the unit
Aspirator (Fan) Failure	The ASD aspirator has stopped functioning	Contact the manufacturer's representative to replace the unit
Low Voltage	The ASD unit input voltage is low	<ul style="list-style-type: none"> • Check power supply to verify if it is operating properly and standby batteries are not depleted • Verify the correct voltage is being provided at the unit
Low Air Flow (Minor)	<p>The air flow in the ASD unit has decreased 20%-50% below the programmed threshold. This may be caused by:</p> <ul style="list-style-type: none"> • An undocumented change in the piping • The aspirator not functioning at the required speed • Obstruction of sampling hole(s) • Obstruction in the sampling pipe 	<ol style="list-style-type: none"> 1. Perform a visual inspection of the sampling pipe system to ensure no modifications were made 2. Verify the aspirator is functioning at the required fan speed. Increase fan speed to the next level, to improve flow performance 3. Clean sampling holes 4. Clean piping network <p>Refer to Maintenance Guide for pipe network cleaning</p>
Low Air Flow (Major)	<p>The air flow in the ASD unit has decreased more than 50% below the programmed threshold. This may be caused by:</p> <ul style="list-style-type: none"> • An undocumented change in the piping • The aspirator (fan) is not functioning at its designed speed • Obstruction of sampling hole(s) • Obstruction in the sampling pipe 	<ol style="list-style-type: none"> 1. Perform a visual inspection of the sampling pipe system to ensure no modifications were made 2. Verify the aspirator is functioning at the required fan speed. Increase fan speed to next level, to improve flow performance 3. Clean sampling holes and piping network <p>Refer to Maintenance Guide for pipe network cleaning</p>
Flow Fault EN54-20	A +/- 20% change in the volumetric flow of air through the chamber will generate a flow fault indication at the ASD unit	<ol style="list-style-type: none"> 1. Perform a visual inspection of the sampling pipe system to ensure no modifications were made 2. Verify the aspirator is functioning at the required speed 3. Clean sampling holes and piping network <p>Refer to Maintenance Guide for pipe network cleaning</p>

Fault Description	Cause	Recommended Action
Configuration	The ASD unit configuration validation fails.. Device is interrupted during the initial configuration process	<ul style="list-style-type: none"> • Perform a reset to revert the unit to its last good configuration • Re-configure the ASD unit utilising the manufacturer's computer based programming software • Configure the ASD unit if the unit is new
Sensor Fault	The ASD unit has a problem with the particulate sensor, which needs to be immediately replaced.	Call a manufacturer's representative to service the ASD unit.
External Monitor	External monitor detects circuitry issues within the ASD unit	Check the external monitoring connectivity
Time	The ASD unit is equipped with a real-time clock that is maintained for 72 hours after loss of power. If the ASD loses power for more than 72 hours, the TIME fault occurs	Update the ASD unit time
Communication	The ASD unit has failed to communicate with one of its peripherals and cannot function properly	<ul style="list-style-type: none"> • Check the ASD network wiring. Verify that all connections are tight and no wires are broken • Verify that the ASD and peripheral devices are programmed properly • If using intelligent FFAST, verify the SLC has not been lost
Filter	The filter has either been removed or could be clogged	The filter needs to be installed or replaced. If the filter is removed it will power down the unit
Disable/Isolate	The ASD unit has been put into DISABLE/ISOLATE mode	Press and release the DISABLE/ISOLATE button on the ASD unit to remove the system from DISABLE/ISOLATE mode
High Flow (Minor)	<p>The air flow in the ASD unit has increased 20%-50% of the programmed threshold. This may be caused by:</p> <ul style="list-style-type: none"> • An undocumented change in the piping • The aspirator fan is not functioning at its designed speed • The piping may be damaged or broken 	<ol style="list-style-type: none"> 1. Perform a visual inspection of the sampling pipe network, to ensure no modifications were made 2. Verify the aspirator fan is functioning at its designed speed 3. Examine all pipes and repair damaged sampling pipes
High Flow (Major)	<p>The air flow in the ASD unit has increased more than 50% of the programmed threshold. This may be caused by:</p> <ul style="list-style-type: none"> • An undocumented change in the piping • The aspirator fan is not functioning at its designed speed • The piping may be damaged or broken 	<ol style="list-style-type: none"> 1. Perform a visual inspection of the sampling pipe network to ensure no modifications were made 2. Verify the aspirator fan is functioning at its designed speed 3. Examine all pipes and repair damaged sampling pipes

Section 5

**Data Centres /
Electronic Equipment Installations**

Application Overview

Businesses and governments both large and small depend on information technology (IT) systems to support their operations by storing, retrieving, transmitting, and manipulating data – often on a 24/7 basis. Examples include financial and accounting databases, sales order data processing applications, business e-mail, file transfer systems, data archives, and cloud computing.

The major components of IT operations are typically housed in a facility known as a data centre. Data centres house computer systems and associated components, such as telecommunications and IT storage systems. These facilities are highly specialised electronic equipment environments that utilise redundant or backup power supplies, redundant data communications connections, environmental controls (e.g., large volume air conditioning), specialised fire suppression systems, and secured access systems.

Data centre facility fires are rare events. However, a major concern for data centre managers is to prevent any downtime at all, because it can be incredibly costly and disruptive. A small fire in a piece of electronic equipment can result in extensive equipment damage and serious and costly interruption of IT operations and services. Some basic reported facts on downtime losses are:

- A 2013 report by the Aberdeen Group indicates the average loss for a small business is about \$8,600 per hour of downtime and for a large organisation, the average costs are more than \$686,000 per hour of downtime. (See Figure 1 to the right)
- Government regulations (e.g., HIPPA, Sarbanes –Oxley, FINRA), require organisations to maintain and make available critical applications and data. Fines for non-compliance results in billions of dollars of costs each year
- A direct result of downtime is often lost revenue at an estimated cost average of \$138,000 per hour for every hour of a downtime event. (Source: Aberdeen Group, *Data centre Downtime: How Much Does it Really Cost?*, March 2012)
- Indirect costs are more difficult to quantify but can be significant. Examples include lost employee productivity, the cost of employees' time to recreate lost work, the damage of a firm's reputation or brand, and a resulting loss in customers
- Large organisations are subject to the largest losses, but small firms can also experience critical impacts to their business. Companies with fewer than 100 employees are subject to a loss of \$12,500 downtime for a single server. A study by DTI/Price Waterhouse Coopers showed that 7 out of 10 small firms that experienced a major data loss go out of business in less than a year. (Source: *Contingency Planning, Strategic Research Corp. and DTI/Price Waterhouse Coopers, 2004*)

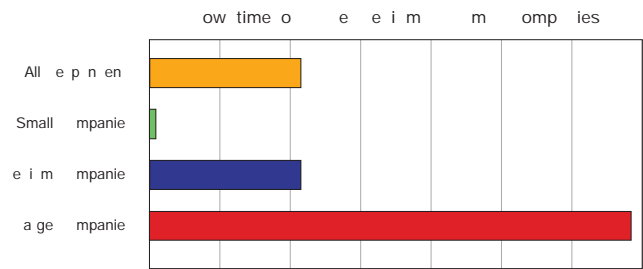

Figure 1. (Source: Aberdeen Group, *Downtime and Data Loss: How Much can You Afford?*, August 2013)

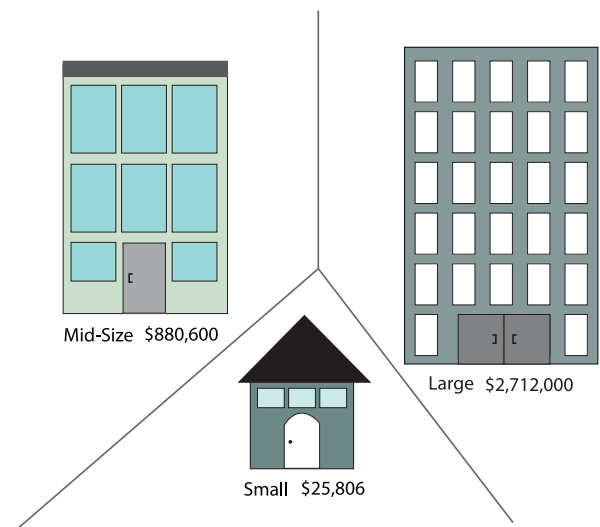

Figure 2. - Average Annual Downtime Loss for Small, Medium and Large Firms (Source: Aberdeen Group 2012)

Benefits of Aspirating Smoke Detection

The IT staff and IT managers of data centres have a primary responsibility of keeping hardware and software systems running. One study (Source: *Continuity Central, The top causes of downtime explored, Q1 2013*), notes that failures in the data centre environment fall into four basic categories. Failures are comprised of:

- 55% hardware failures
- 22% network failures
- 18% software failures
- 5% natural disasters, of which fire is one cause for failure

Therefore, if 95% of IT failure issues are related to electronic systems, it is easy for staff to be routinely focused on the electronic data system operations and far less focused on the omnipresent risk of fire in this environment.

While fire may be low probability event, even the smallest fire events can be high-consequence events in a data centre environment. The potential lack of fire-related vigilance can be overcome by the presence of aspirating smoke detection systems that actively monitor the ambient air throughout a data centre.

Given the direct dollar loss and indirect losses possible due to a fire in a data centre environment, the need for identification of the smallest fire events – such as precursor smouldering or overheating equipment – can be critically important. Aspirating smoke detection systems can provide the high sensitivity and continuous sampling of low quantities of smoke that may be distributed and easily diluted by the high-airflow environments in data centres. Digital Equipment designed to the highest standards (UL 60950, NEBS GR63) have components and shut down features that minimise the production of smoke, yet an incident may only have a chance of being detected with the use of aspirating smoke detection systems.

Due to concerns for potential damage to sensitive electronic components, automatic fire protection systems that use water, water mist, aerosols, or foam often may not be employed in data centre spaces. However, clean agent or inert gas systems may be found more frequently in such spaces. If no extinguishing system is present, the need for very early identification of a fire or precursor event is of greater importance. This need can be readily served by aspirating smoke detection systems. Aspirating smoke detection provides high sensitivity to smoke with low sensitivity to airflow, a combination of features not provided by conventional smoke detectors. In those cases where any of the fire protection/suppression systems noted above are installed in the data centre space, there is an equally important need to identify and investigate an alert or alarm condition prior to an extinguishing system operation. It has been reported that most fixed fire extinguishing system activations in data centres are false or nuisance-type events.

A side effect of some extinguishing system operations (gaseous agent systems), is the need to completely or partially shut down air handling equipment and close airflow dampers to contain suppressants. Such a shut-down can result in significant temperature rise in the data centre and disruption of electronics. Therefore, early staff response initiated by an aspirating smoke detection system can result in confirmation of the need for aborting extinguishing system operation and any associated air handling shut-down. Conversely, an early staff response can result in manual fire suppression intervention or de-powering a section of equipment that appears as an ignition or fire source.

Data centres consume 25-50 times or more electrical energy as standard office spaces. Basic design documents for data centres indicate that planned energy usage should be 50 watts to 100 watts per m²/ft.², and many designs will approach or exceed 200 watts per ft². As a result, the total and concentrated heat load of the electronic equipment needs to be managed to keep equipment within proper operating temperature ranges.

To accomplish this, large air flows are required with the basic objective of supplying cool air to the equipment and removing hot exhaust air. Depending on the location within the data centre facility (under raised floors, ceiling ducts or plenums, rack cabinets), air flow velocities can range from 0.25 m/s - 15.2 m/s (50 - 3,000 fpm), while air temperatures range from 10° C - 60° C (50° F -140° F).

Standard smoke detectors are generally not capable of performing in high air flows. Because of room air currents dilution and stratification phenomenon, sufficient smoke may not be able to reach a ceiling-mounted detector, and if smoke can penetrate to a standard ceiling-mounted detector, there may not be a sufficient quantity of smoke to activate it.

NFPA 72 specifically requires that unless a smoke detector is recognised for use in specific air flow environments, it should not be used in air flow environments over 1.54 m/s (300 fpm). Both BS 6266 and NFPA 72 recognise the challenges of detecting smoke in high-airflow environments and stipulate reductions in spacing of detection points in such high-airflow conditions.

BS 6266 provides guidance specific to adjustments needed in electronic equipment installations. The advantages of a using an aspirating smoke detection system are related to providing detection at very low particle levels and in high-airflow environments. Consider that a standard spot smoke detector operates in the range of 1.5 to 3.0 % obs/ft.; whereas, the aspirating detection system can be programmed to provide sensitivity for detection as low as 0.0015% obs/m (0.00046% obs/ft.). Aspirating detection systems are up to the challenge of the high-airflow environments of data centres with the capability of detection in 20.3 m/s (4,000 fpm) environments.

Design Best Practices

Identify and Understand the Airflow Management Scheme

There are numerous approaches to providing air distribution and equipment cooling in data centres. Understanding the approach that is applied in any given facility will allow the designer to identify the key airflow paths as well as areas where airflow is minimal and not likely to carry smoke particulate to a sampling port location. While other approaches (including hybrid) are possible, distributing air in a data centre usually involves one or more of three basic approaches. Automatic detection requirements for data centres are based on NFPA 75 and 72 provisions. The FIA CoP for ASD Systems provides design and installation guidance for aspirating smoke detector systems used in data centres and other environments, and has been coordinated with BS 6266.

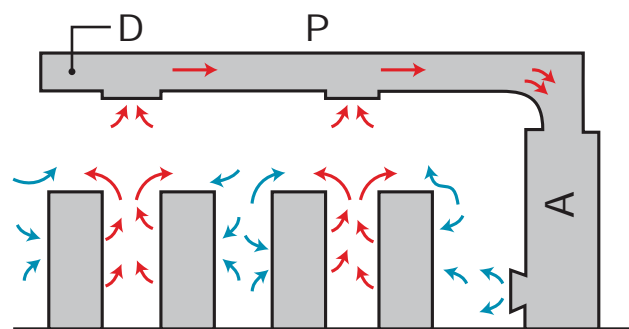

A flooded supply with a targeted air return scheme. Hot air can mix with cold air supply.

Figure 3

Flooded

This approach uses a supply and return air distribution system in which the only constraints to the airflow are physical boundaries of the room or space (walls, ceiling, floor). Due to the extent of hot and cool air mixing, sampling points are recommended at the ceiling and at the HVAC/CRAC (computer room air conditioning) unit air returns and supply-side outlet grills.

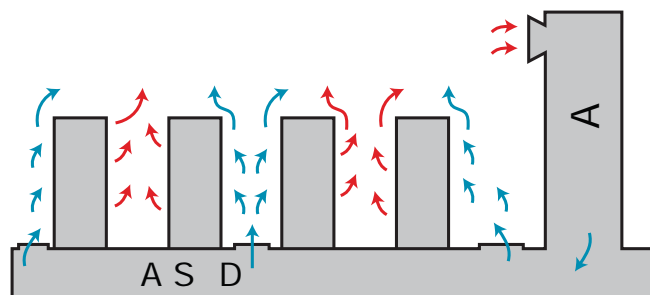

A targeted air supply with a flooded return air system. Cold supply air mixes with hot return air.

Figure 4

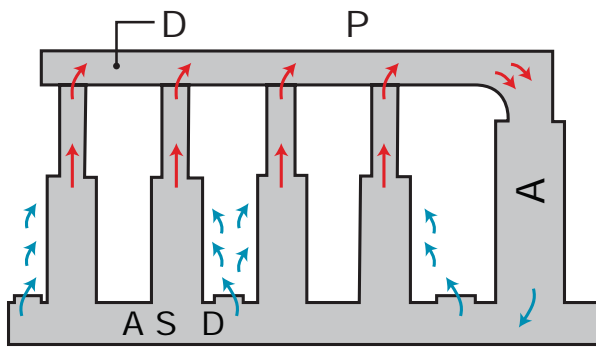

Targeted supply air with contained hot exhaust air capture.

Figure 5

Figures 3., 4., 5. – Examples of air flow schemes for Data Center equipment rooms

Targeted

This approach also uses a supply and return air distribution system. However, the supply or return is placed near or adjacent to the IT equipment through the use of ducts, perforated tiles, or even a piece of localised equipment within the IT racks in an effort to direct the airflow to/from the IT equipment.

Contained

This approach also uses a supply and return air distribution system, where the IT equipment supply and/or return airflow is completely or partially enclosed to minimise or eliminate air mixing. These contained approaches are also known as hot aisle/cold aisle configurations. For reasons of energy efficiency and cooling effectiveness the contained approaches using hot and cold aisle designs are now common approaches found in data centres. Ceiling sampling points are recommended for fire sources outside of IT cabinets. Direct sampling of the hot air return ducts or the interior of the equipment cabinets are areas for placement of sampling.

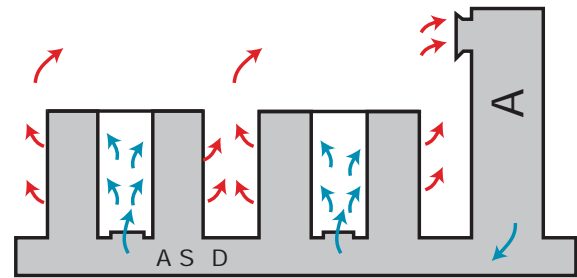

Contained supply air (cold aisle). Flooded hot air return.

Figure 7.

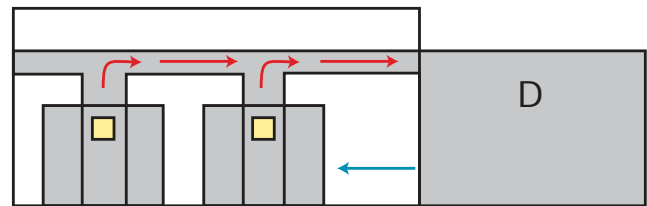

Flooded supply air with air contained hot air return. Outdoor unit accommodates economizer cycles.

Figure 8

Figures 6., 7., 8. – Examples of air flow schemes for Data Center equipment rooms

More on Hot Aisle/ Cold Aisle Configurations

Hot aisle/cold aisle configurations are created when the equipment racks and the cooling system's air supply and return are arranged to prevent mixing of the hot rack exhaust air and the cool supply air drawn into the racks. A basic layout of both hot and cold aisles has data centre equipment arranged in rows of racks with alternating cold (rack air intake side) and hot (rack air heat exhaust side) aisles as shown in Figure 9 on the following page.

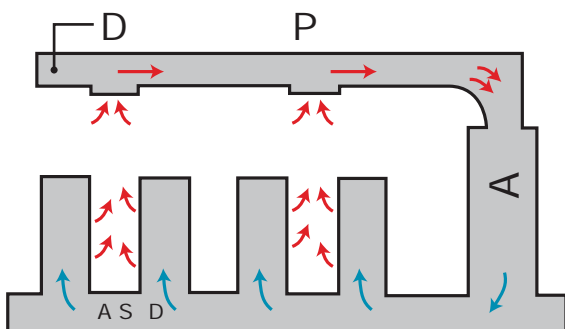

Contained supply air direct to IT cabinets. Targeted hot air return.

Figure 6.

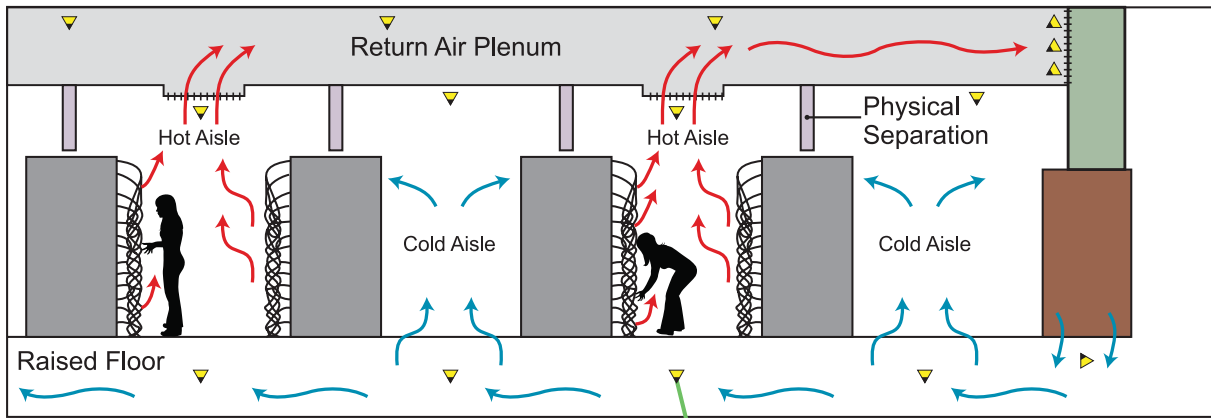

ene al n ep an l ai le ai managem n ep
 S n a e pi al ai ample p in l ai n
 n e ai e l e in e e i emen m i le p e en
 Sampling p in l a e in ai l ig ai el i e i en le
 n a a ing in ai l See S le pa ing a men
 A e elling e n ai plen m e in e e i emen m i le p e en
 See S le pa ing a men
 el elling gene al a ea p e i n
 p ai le ai an e g ill
 A ni ai e n A ange ep a ea e n m e an m e e n pening ien le
 e m in ming ai l ain ain an i an e app ima el in m
 A ni l ai ppl le p e en ing an el mal n in A ange ep a ea e n m e an
 m e ppl le ien le e m in ming ai l

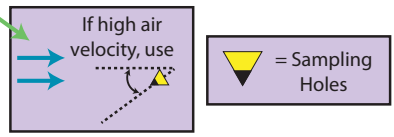

Figure 9. – General Concept of Hot and Cold Aisle Air Management in Data Centers

The aisles are typically wide enough to allow for maintenance access to the racks and meet any code requirements. All equipment is installed into the racks to allow for a front-to-back airflow pattern that draws conditioned air in from cold aisles, located in front of the equipment, and exhausts heat out the back side of the racks into the hot aisles (or sometimes the top of the rack into collars or exhaust duct systems). Rows of racks are placed back-to-back, and holes through the racks (empty equipment slots), must be blocked off on the air intake side to avoid recirculation.

With a raised floor, the same airflow is achieved with the supply coming from tiles in the cold aisle. Using hot aisle/cold aisle configurations, proper isolation can be achieved and the temperature of the hot aisle no longer impacts the temperature in areas beyond the hot aisle. The hot aisle becomes a heat exhaust. The HVAC system serves to supply cold air only to the cold aisles and pull return air directly from the hot aisles to avoid the losses and inefficiency that would result from mixed airflow environments. Figure 9 above illustrates a best-case situation, where both the hot aisles and cold aisles are contained, but some designs may rely solely on a cold aisle containment arrangement or a hot aisle containment arrangement.

In a cold aisle containment arrangement, a physical separation is provided between the cold air and hot air exhaust by enclosing only the cold aisle. In this case, the spaces around the cold aisle become hot-air-flooded areas and such areas will have higher ambient temperatures. Conversely, in a hot aisle containment arrangement, a physical separation is provided between the cold air and hot air exhaust by enclosing only the hot aisle. This is intended to capture all the hot air exhaust and return it to the cooling areas. With containment limited to the hot aisle, the remainder of space outside the hot aisle becomes a room flooded with cold air from the HVAC/CRAC unit.

Many types and variations of hot aisle/cold aisle arrangements are possible. A few arrangements of typical applications are illustrated in Figures 10, 11, 12. (to the right and on the following page). The containment curtains shown are generally vinyl transparent plastic sheets. While these vinyl sheets serve to control and contain airflow, they can cause complications in

terms of blocking sprinkler discharge or preventing clean agent gases from being distributed effectively throughout the space and into the electronic equipment.

Although spot detectors are sometimes considered for these containment applications, their performance can actually be impaired due to high airflow and the limitation of being able to detect smoke at a spot location subject to high airflows. Aspirating detection can overcome these limitations and offers advantages in capabilities over spot detectors. Outputs from the aspirating detection systems can be useful for the automatic release of vinyl curtains (allowing them to drop away), prior to operation of sprinkler or clean agent systems.

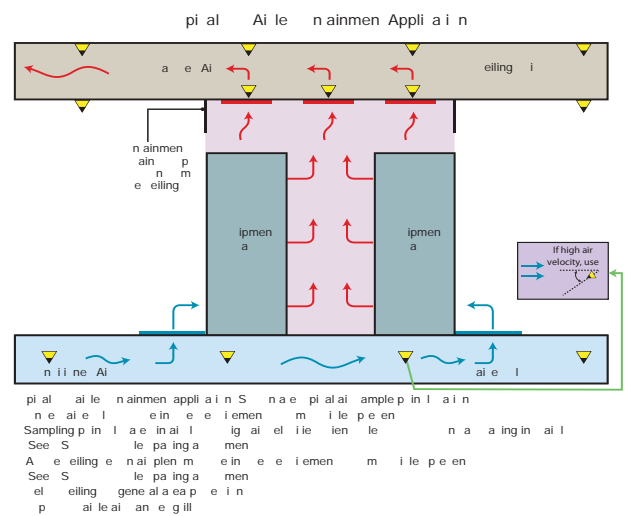

Figure 10. - Hot Aisle Containment application

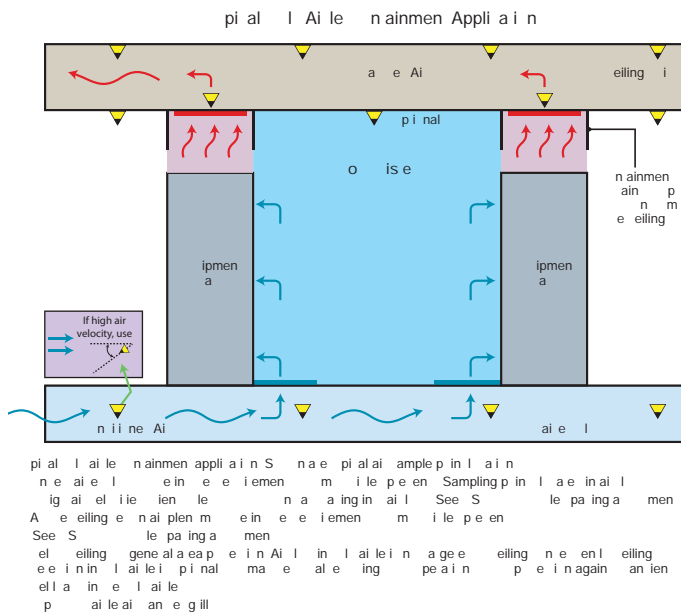

Figure 11. – Cold Aisle Containment application

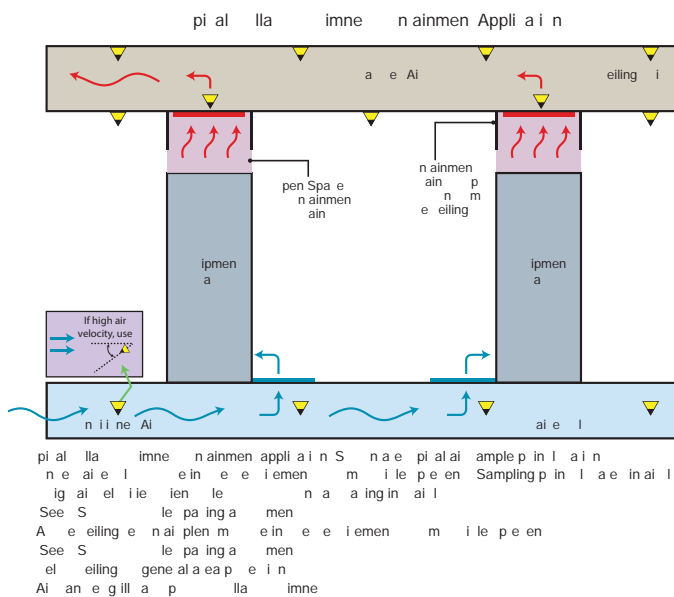

Figure 12. – Collar or Chimney Containment application

Locations for Air Sampling Points of IT Equipment Spaces

Large quantities of wire and cable are in data centres. Such cables are often routed through concealed spaces that include the areas above ceilings and below raised floors. Raised floors having cables are generally protected with detection systems when the fire and flame propagation characteristics do not meet appropriate standards. NFPA 75 and insurance carriers have specific requirements for the areas above ceilings and below raised floors containing cables.

HPR (Highly Protected Risk) insurance standards tend to prefer Very Early Warning Fire Detection (VEWFD) technology, which is readily provided by aspirating smoke detection system technology. The following provides added detail about reasons for deploying aspirating smoke detection in the areas above ceilings and below raised floors.

Raised Floors: Although data cables do not have the energy potential to initiate fires, they do pose a significant fuel load and are subject to the ignition sources posed by power supply cables or other potential sources. NFPA 75 requires automatic detection systems below raised floors of IT equipment areas when the raised floor area contains combustible cables. Should PVC cables or other plastics ignite, a serious risk of both thermal and non-thermal damage results. Halogen acid gases (hydrogen chloride, hydrogen bromide, hydrogen fluoride), and carbon soot from smouldering or flaming fires can inflict serious non-thermal damage to electronic components. These gases can readily diffuse through the data centre and cause serious corrosion at concentrations as low as 10 parts per million (ppm). In addition, soot can act as either an insulator that interferes with electrical contacts or as an electrical conductor that causes shorts and current leakage in printed circuits and between exposed electrical connections.

The risk of equipment damage from ignited plastic cables can be minimised by the early detection of aspirating smoke detection technology. Furthermore, these systems can provide alerts of a condition in the raised floor so appropriate personnel can respond in a timely manner by removing tiles and locating the area of issue.

Above Ceiling/Below Floor Air Handling Spaces: The ceiling plenums and spaces below raised floors and within walls that define the IT equipment space are often used for air circulation from other building spaces. Consequently, there may be smoke dampers or other protective openings for air return or supply. NFPA 75 requires detection to initiate closing such openings and smoke dampers to eliminate smoke contamination of the IT equipment space. NFPA 75 requires one or more of the following three methods to be used:

- Detection throughout the above ceiling space or below floor air circulation space
- Detection located at each smoke damper
- Detection at other locations where smoke may be transported into the IT equipment space. (E.g., door opening from a non-IT equipment space)

Smoke contamination from IT equipment space fires poses a threat that can be easily identified with aspirating smoke detection technology. Air sampling points can be installed at each damper location to sense smoke and initiate the damper closing operation. If a large number of dampers or other openings need to be controlled, then it may be beneficial to install detection sampling points throughout the ceiling plenum or raised floor plenum. This can be an effective installation because these concealed spaces may have wiring and cables that warrant detection.

Ceiling Level: Airflow path locations, such as return air grills or in-duct air sampling points, are often convenient locations for aspirating smoke system sampling points. NFPA 75 requires early warning automatic detection systems at the ceiling level throughout IT equipment areas. Although various types of detection could fulfil this requirement, NFPA 75 does note that air sampling detection devices should be considered, due to the high air flow nature of the data centre environment. Aspirating systems operate over a wide range of airflows from 0-20 m/s (0 to 4,000 fpm), and can be programmed for sensitivities ranging from Early Warning Fire Detection (EWFD) to Very Early Warning Fire Detection (VEWFD). Aspirating detection at the ceiling fulfils basic or high sensitivity detection throughout the space, whether the data centre is operating in full air movement mode or during a service outage or equipment replacement period. Data centres are subject to equipment refresh and layout changes, during which packaging materials and combustible boxes can present a transient fire risk anywhere in the data centre.

The provision of ceiling-level detection assures that such common combustible fire risks are monitored by continuous air sampling from the aspirating smoke detection smoke sensor.

HVAC/CRAC/CRAH units: HVAC systems for data centres are usually referred to as CRAC or CRAH units (Note: these terms tend to be used interchangeably in the industry). These air conditioning units monitor and maintain the temperature, air distribution, and humidity in a network room or data centre. A CRAC unit is exactly like the air conditioner at your house: the compressors that power the refrigeration cycle are also located within the unit, and cooling is accomplished by blowing air over a cooling coil filled with refrigerant. A CRAH is constant volume and can only modulate on and off. Some manufacturers have developed CRAC units to vary the airflow using multi-stage compressors, but most existing CRAC units have on/off control only. A CRAH unit works exactly like a chilled water air handling unit found in typical commercial office buildings: cooling is accomplished by blowing air over a cooling coil filled with chilled water. Chilled water is supplied to the CRAHs by a chilled water plant. CRAHs can have VFDs that modulate fan speed to maintain a set static pressure, either under floor or in overhead ducts.

Fan motors, fan belts, power wiring, and filters are potential ignition and fire sources. A smouldering wire or small filter ignition can introduce smoke into the cooling air stream. Consider placing sampling points downstream of the filters – on the supply air side of the CRAC or CRAH units – to recognise smoke before it's circulated through sensitive electronics.

Outdoor fires and fires in properties adjacent to a data centre can pose a risk of smoke and chemical contamination in an electronics environment. The risk can be significant in the case of large fires, such as a wild-lands fire or a nearby burning building. HVAC systems that draw outside air and use energy-saving economiser cycles can potentially introduce smoke-laden air into the data centre in a short time frame. The economiser cycle is used to save energy in buildings by using cool, dry outside air as a means of cooling the indoor spaces, but is not typically employed in hot, humid climates.

Aspirating smoke detection systems (with sensors located at appropriate points in the HVAC), should be considered as follows:

- **Outside air intake** – install air sampling points in the outside air section, downstream of the outside air damper but upstream of the filters. This arrangement detects smoke-contaminated outside air entering the building
- **Main return air intake** – air returning through systems using an economiser cycle is subject to high efficiency air filters (MERV 11 or 13) that filter smoke before it returns to the conditioned space. If a fire incident occurs in the return air system or plenum, smoke could be removed by MERV filters before being sampled in the conditioned space. To assure detection before filtering occurs, install air sampling points upstream of the return air fan and filters at the HVAC system's main return air intake

Critical/High Risk Equipment Scenarios: Data centre electronics equipment ranges from redundant and readily replaceable to critical and valuable. Depending on the level of overall importance to the network and storage operation, various equipment installations may pose high consequences in terms of loss of function and loss of high-value or irreplaceable items. When such equipment scenarios are present, aspirating smoke detection is advised for earliest warning and initiation of human response.

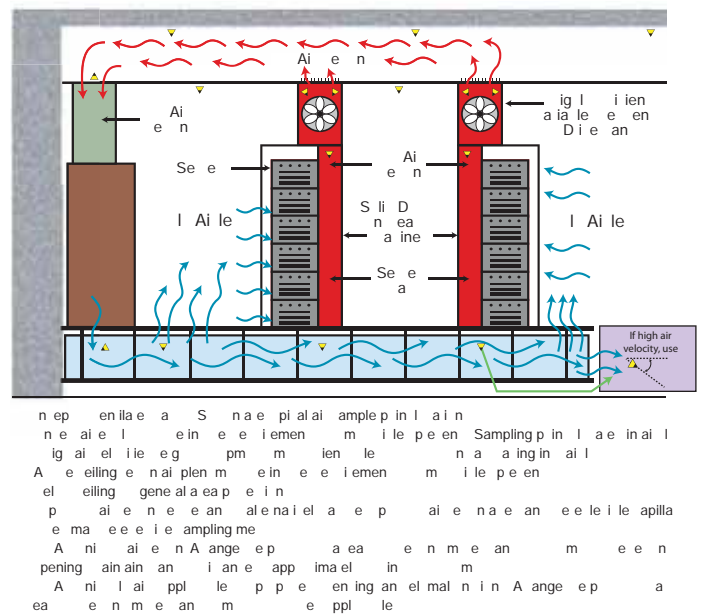

Figure 13. – Ventilated Racks Using Enclosed Cabinet on Hot side. Air sampling ports best provide at top of cabinet just before fan location.

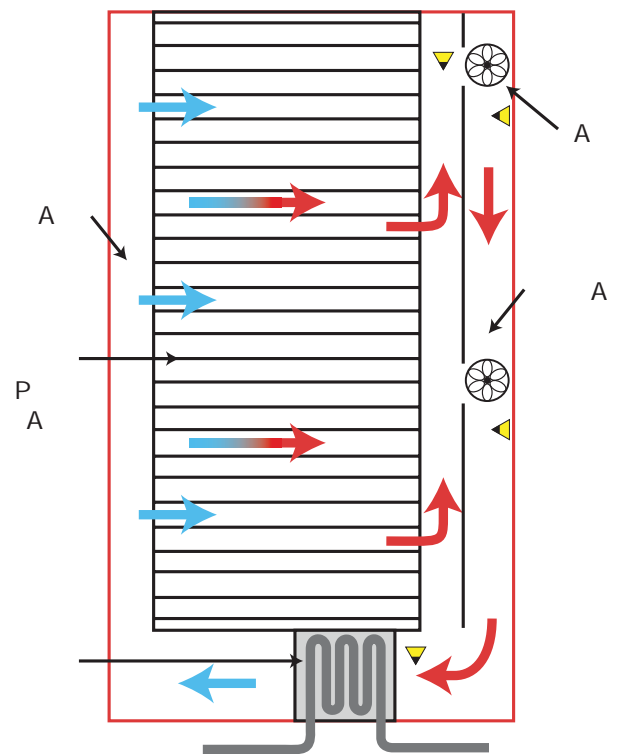

Figure 14 – Rack with fully integrated cooling system.

Ventilated IT Equipment Racks: Ideal air management and cooling schemes for equipment racks use cooling systems integrated with plenums contained within the rack enclosure (See Figures 13 and 14). In these highly efficient designs, cool air is directed to the intake side of the rack and hot air is exhausted from the opposite side. In-cabinet sample points can also be an effective detection scheme, but the sampling points must be placed on the hot air return side.

Coordination and Interface with other Systems

Fire Protection Systems: fire protection systems in data centres may be implemented in a number of ways.

- Automatic sprinkler systems only
 - Wet systems
 - Pre-action – non-interlocked, single interlocked, double interlocked
- Automatic sprinkler systems with supplemental clean agent systems
- Water mist systems only
- Water mist systems with supplemental clean agent systems
- Clean agent systems only

Often the system choice and implementation depends on owner/operator concerns for equipment water damage. Depending on the fire protection system(s) used, there could be a need for a fire detection system interface to initiate sprinkler pre-action valve operations, damper closing operations prior to clean agent release, or shut-down of HVAC systems and de-powering of equipment. Aspirating smoke detection plays an important role in these operations by providing alerts and alarms at appropriately set smoke detection levels. An aspirating smoke detection system's alert and action settings initiate early staff response, which can confirm the shut-down of extinguishing system operations as well as associated air handling. However, if there is a threatening fire in development, the typical Fire 1 and Fire 2 alarm settings can be programmed to initiate pre-action valve release or clean agent release. Where a sprinkler or water mist system is supplemented by a clean agent system, there may be a desire to control suppression/extinguishing system operations with two alarm levels of an aspirating smoke detector (i.e., Fire Alarm 1 and Fire Alarm 2), or to use two independent detection systems. For example, an aspirating detector may be used for sprinkler pre-action valve control while a second detection system is used for clean agent release after an appropriate time delay period (e.g. 30 seconds). Alternatively, a Fire Alarm 1 Level may be used for sprinkler pre-action valve control and the Fire Alarm 2 Level used for clean agent release. Aspirating smoke detection systems provide the early response needed to initiate an extinguishing system in the event of a developing fire. Quick water application and system effectiveness is typically improved by early operations during the fire event. Aspirating smoke detection systems provide this capability to assure prompt extinguishing system action.

HVAC Systems and De-powering operations: Electrical power supplies in data centres serve as an ever-present ignition source. Electrical systems in data centres allow for de-powering equipment that may be source of ignition and re-ignition energy after extinguishing systems operate. De-powering may be accomplished using manual power disconnect features or done automatically. Aspirating smoke detection can be valuable to the sequence of de-powering operations. Prematurely shutting down HVAC systems can cause an immediate temperature spike in the facility and result in damage to electronics equipment.

Early staff response initiated by an aspirating smoke detection system's alert and action settings can confirm the need for any associated air handling shut-down. Also, should an actual fire event transpire, the typical Fire 1 and Fire 2 alarm settings can be programmed to initiate pre-action valve release (or clean agent release), HVAC shut-down and equipment de-powering. The de-powering of equipment assures better clean agent suppression, and there's less chance of equipment damage with the electrical power removed.

Common Issues/Application Troubleshooting

There are several considerations for the use of aspirating smoke detection within data centres. During the design phase, the following factors should be considered:

- The designer needs to verify the airflow and direction of air within the space to maximise the system's effectiveness. The sampling points should be installed in the direction of the airflow
- For a large detection system with many sampling holes, the designer needs to account for smoke/air dilution. The more sampling holes the air sampling pipe contains, a greater volume of air is returning to the aspirating detector; this can dilute the quantity of smoke within the detection chamber and may delay the time it takes to initiate the alarm within the detection chamber
- The location of the sampling holes within the detection network is a concern. The further the sampling hole is located from the aspirating smoke detector, the more air/smoke dilution occurs, which could delay the time it takes to initiate the alarm within the detection chamber
- In normal applications, it is common for the air pressure in the protected room (PR) to be the same as the air pressure where the air is being exhausted from the detector (PE). The design software that is used to calculate transport times and detector sensitivities assumes equal air pressure in the two spaces. The sampling hole size, pipe size, transport time, and the fan aspirator speed are all functions of the air volume that passes through the sampling chamber. The sensing chamber is designed to detect smoke particles moving through the chamber at the speed of the fan. If PR is greater than PE, the velocities of the sampled air entering the chamber could be higher than the nominal fan speed, which could directly impact the detector's ability to sense smoke particles. Conversely, if PE is greater than PR, air pressure builds on the exhaust air, causing resistance and a drag on the fan. As a result, the fan may operate slower than designed, causing an increase in transport times and less air going into the sensing chamber. To eliminate the pressure difference, the exhaust air needs to be piped into the same room that is being sampled.

During the commissioning process, the installing contractor needs to properly program the alarm thresholds and sensitivity levels because both could significantly impact the aspirating smoke detector's performance. The following programming considerations should be considered:

- Typically, aspirating smoke detectors are shipped with default settings from the factory. These generic settings are not appropriate for all detection systems because they may be either too sensitive or not sensitive enough for a specific application. It is necessary for the aspirating system designer to determine the alarm levels and program the sensor accordingly. The sensitivity levels and alarm thresholds are derived by a combination of the computer-based calculation program, the hazard being protected, detection system size and engineering judgment

- The programmable sensitivity levels are another significant issue impacting the performance of aspirating smoke detection systems. The detectors contain sophisticated electronics and software that allow the device to be programmed to a wide range of sensitivity levels. If these alarm levels are not programmed properly, then the quantity of smoke necessary within the sensing chamber may exceed the desired sensitivity and cause a delay in alarm signal initiation.

Time delays for trouble and alarm signal activation are also included at the detector. These delays can be set for a range of times, but typically span from 10 to 30 seconds. Consideration should be given when programming the time delays. The greater the delay, the longer it will take for the detector to initiate an alarm signal.

Dos

- Identify applicable codes and insurer's requirements
- When NFPA 75 (Standard for the Fire Protection of Information Technology Equipment) applies, the following is recommended:
 - Review the documented risk assessment for the information technology equipment areas and all recommendations for automatic smoke detection
 - Apply aspirating smoke detection when early warning smoke detection is required for 1) the ceiling level throughout the IT equipment areas, and 2) below the raised floor of IT equipment areas containing cables
 - Apply sampling port in the above ceiling space or below a raised access floor of an IT equipment area, when air circulates to/from other areas via these IT area concealed spaces. One or more of the following installations should be used: 1) throughout the concealed air movement space, 2) at each smoke damper, or 3) at other locations necessary to detect smoke entering or exiting the IT equipment area
 - Assure that alarm and trouble signals from aspirating smoke detection systems are annunciated at a constantly attended location
 - Confirm and implement how alert and fire alarm settings are integrated to initiate the following if applicable: 1) power shut-down, 2) pre-action system valve operation, 3) gaseous agent release, 4) water mist system release, 5) air handling shut-down and associated damper or door closures, 6) release of aisle air flow containment systems (e.g. vinyl curtains), that obstruct agent delivery from sprinkler or gaseous agent systems
- When BS 6266 (Fire protection for electronic equipment installations – Code of practice) applies, the following is recommended
 - Review the documented risk assessment for the electronic equipment areas and understand which areas classify as medium, high, or critical risk electronic installations
 - Identify where Class C, aspirating smoke detection type smoke detection is to be applied
 - Identify where Class B, aspirating type smoke detection is to be applied. Class B systems are used when increased sensitivity is needed to compensate for dilution effects due to high ceilings or moving airflows
 - Identify where Class A, aspirating type smoke detection is to be applied. Class A systems are used in areas with high air movement

and smoke dilution, or where the very earliest warning is needed to protect critical business operations, high value data processing or high value electronic equipment

- Install sampling holes for optimum effectiveness in accordance with Annex A provisions of BS 6266 for air return vents, ceilings, below floor and above ceiling void spaces, in-cabinet locations, and proximity to air inlets and ceiling fittings
- Apply the rules of BS 6266 where aspirating type smoke detection is applied
- Confirm and implement how alert and fire alarm settings are integrated to initiate the following if applicable: 1) power shut-down, 2) pre-action system valve operation, 3) gaseous agent release, 4) water mist system release, 5) air handling shut-down and associated damper or door closures, 6) release of aisle air flow containment systems (e.g. vinyl curtains), that obstruct agent delivery from sprinkler or gaseous agent systems.
- Understand the airflow environment and coordinate air sampling points with key points of return and supply air movement
- Follow the spacing rules of applicable installation standards and/or insurance carrier requirements
- Consider sampling ports both under cable trays and at the ceiling when cable tray density and arrangement may impede smoke flowing to the ceiling
- Provide sampling ports to monitor HVAC/ CRAC/ CRAH air returns. Arrange the ports so that each covers no more than 0.4 m² (4 ft²) of the return opening.
- Identify critical or high-risk equipment installations that should have localised area or in-cabinet air sampling for earliest warning and initiation of human response
- Consider providing sampling ports to monitor outside air intake – install air sampling points in the outside air section, downstream of the outside air damper but upstream of the filters. This arrangement allows for detection of smoke-contaminated outside air entering the building
- Consider providing sampling ports to monitor Main Return air intake of economiser systems – if a fire incident occurs in the return air system or plenum, smoke could be removed by MERV filters before it is sampled by detection point in the conditioned space. To assure detection before any filtering occurs, install air sampling points at the HVAC system's main return air intake, upstream of the return air fan and filters

Don'ts

- Don't exceed the recommended detector or sampling point spacing of applicable standards or insurance carrier requirements.
- Don't use detectors that are not listed or approved for air velocities and temperatures that will be encountered in IT areas or equipment.
- Don't design the aspirating smoke detection system to exceed the transport time requirements of installation standards or insurance company requirements.
- Don't install ceiling sampling points too near to ceiling supply air diffusers. Maintain a distance of 0.9 m - 3 m (3 ft. - 10 ft. from ceiling diffusers depending on the strength of the airflow. (See BS 6566 and NFPA 72 for specific requirements)

Section 6

Telecommunications

Application Overview

Telecommunication lines and systems are not only expected conveniences of businesses and homes, but also key elements of business operations and emergency services. Telecommunication companies spend billions of dollars to ensure reliable voice, data, and video transmission routes by using improved transmission-route switching technology and multiple transmission paths in the telecommunication network, also known as the Public Switched Telephone Network (PSTN).

Facilities that provide telecommunication services to the public are known as “public exchanges” in Europe and “central offices” in North America but they’re also referred to as “telephone exchanges” or “switching exchanges.” These facilities provide services such as telephone transmissions (wireless and land-line phones), data transmission, internet transmission, VoIP transmission (Voice over Internet Protocol), and video signal transmissions (e.g. cable TV). The function of a telecommunications facility is voice and data signal transmission, making it different from the function of a data centre (to manipulate, store, and retrieve data). If telecommunications equipment fails or operations cease due to an unwanted event, then any in-progress data/signal transmission is lost and not recoverable. The transmission paths are as basic as the traditional twisted pair of copper wires (house connected to telephone exchange), but also include: cellular wireless networks, coaxial cable, fibre optic cable and microwave transmission links, communications satellites, and undersea phone cables.

Important system power supplies, sophisticated circuit-switching equipment, and circuit interfaces between local phone carriers and long distance companies are found in thousands of telephone exchange buildings around the world. These buildings may be high-rise structures in major cities or small, one-story facilities in suburban or rural areas. While the size of central offices varies widely, their relative importance to communities they serve is always high. Many are highly automated, meaning that either no staff or only limited staff may be present during standard working hours.

A central office/public exchange represents a highly specialised and sensitive risk environment and typically consists of a variety of equipment and spaces:

- **Cable vaults** - below-grade structures containing the telephone-cable racks and trays entering the site
- **Power areas/rooms** – transformers/rectifiers convert high voltage power company AC current to a lower voltage DC current with battery systems that supply telecom system equipment. Batteries are final source of power if generators fail. See Figure 1 top right
- **Generator rooms** - spaces housing diesel or gas-turbine generators for long-term standby power if power company supply fails
- **Distributing frames** - terminal equipment that supports and positions large numbers of telephone wires at terminal blocks for connection to switching systems
- **Switching equipment areas** – modern day electronic digital switches or electromechanical switching equipment that establishes connections to the telephone network
- **Computer rooms** - spaces housing data-processing equipment that monitors switching equipment, activity, faults, and accounting data
- **Conventional offices, building systems and mechanical rooms**

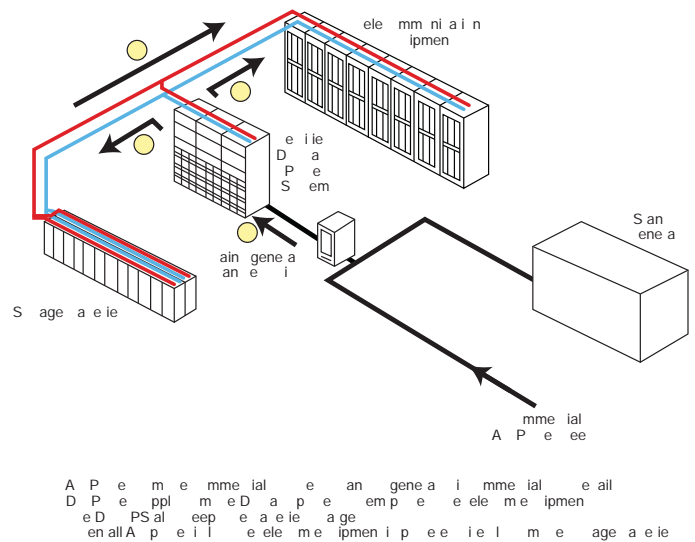

Figure 1. – Power supply scheme for central offices/public exchanges

Fire losses are common in telecommunication exchange buildings, given the nature of electrical equipment systems, combustible cabling, batteries, and associated maintenance activities. The North American fire record in the telecommunications industry has been excellent, with only eight notable incidents occurring from 1975 to 2000 with no occupant or first responder loss of life. This fire record is attributable to the long-time and widespread use of telecommunication equipment and cables with high fire resistance characteristics, as well as high standards for telephone exchange construction in North America. Similar standards are followed in Europe.

Although small, slow developing fires have been the norm for telecommunication buildings, those fires can still significantly impact the services used by businesses and the general public. A review of seven significant incidents in the 1980’s and 90’s showed that the fire did not spread beyond the area of fire origin but still resulted in significant service interruptions. For these seven incidents, the service outages were as follows (see Figure 2 on the following page):

- 5,000 to 113,000 lines/customers interrupted
- Average of 49,900 lines/customers interrupted
- 1-16 days required for restoration of service
- Average of 4 days for restoration of lost services
- Emergency service interruptions
- Smoke damage occurred in areas beyond the room of origin (three incidents)

Because the ramifications of a telecommunication facility fire can be severe – including millions of dollars in lost service, related business interruption and interruption to critical operations (emergency services) – safeguarding against such occurrences has become a top priority for the industry.

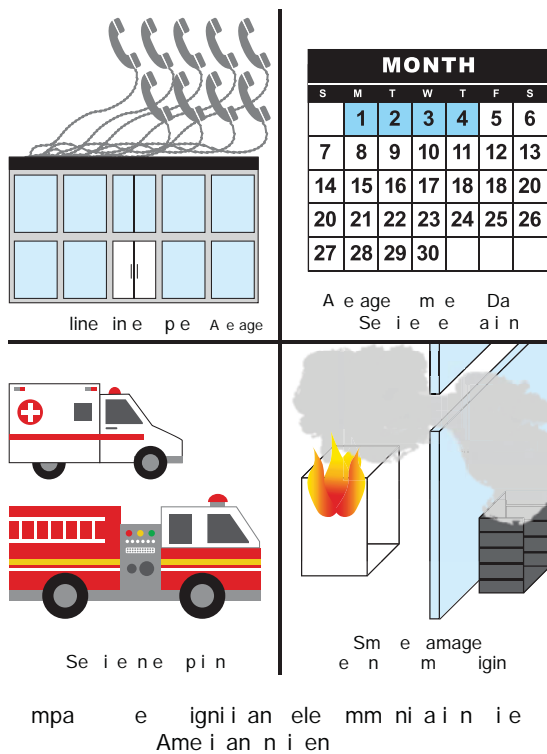

Figure 2. – Loss Impacts

Benefits of Aspirating Smoke Detection

The telecommunications equipment environment is unique because the expected fire development has been predicated on the use of telecommunications equipment and cables with high fire resistance characteristics and associated low energy fire scenarios. Aspirating smoke detection technology is an ideal solution for telecommunications equipment, due to the nature of the fires in this environment and the nature of the threats to the equipment from corrosive smoke, unwarranted suppression system release, or fire department intervention (water application). The following points describe the unique aspects of fires and operations in telecommunications facilities and why aspirating smoke detection technology should be used:

- Most fires are so small they seldom activate standard detection or suppression equipment
- Non-thermal damage effects from corrosive smoke, moisture, and arcing are chief contributors to service outages
- Fire growth rates tend to be slow in telecommunication equipment, and experience indicates burn areas are limited (approximately 15.2 m² - 304.8 m² (50 ft.² - 1,000 ft.²))
- To keep equipment cool, airflows and air change rates are significant and may require shut-down or a smoke mode operation to manage the smoke and prevent contamination
- Power supplies are intended to operate equipment continuously, and typical emergency power-off capability (as required by electrical codes), is not provided because the use of telecommunications equipment and the consequences of disconnecting power can be severe (loss of voice/data/signals transmission)

- Automatic extinguishing systems, including both water-based and gaseous agents, often have limited value due to their inability to extinguish fires involving highly redundant reliable telecommunication power supplies. Extinguishing-agent discharge can aggravate and enhance non-thermal damage effects

Fire may be a low probability event in a telecommunications equipment environment, but even the smallest fire events can have severe consequences. The potential lack of staff presence and vigilance can be overcome by aspirating smoke detection systems that actively monitor the ambient air throughout telecommunications equipment areas.

Given the potential losses for telecommunication facilities, it's critical to identify small fire events like precursor smouldering or overheating equipment. Aspirating smoke detection systems can provide high sensitivity and continuous sampling of low quantities of smoke that may be distributed and easily diluted by high airflow environments. Digital equipment designed to the highest standards (UL 60950, NEBS GR63), has components and construction features that minimise heat release and the production of smoke, yet an incident may only have a chance of being detected with the use of aspirating smoke detection systems.

Due to concerns for extensive damage to sensitive electronic components or general effectiveness, automatic fire suppression systems that use water/water mist/aerosols/foam are generally not employed in telecommunications equipment spaces. However, clean agent or inert gas systems may be found in some telecommunications facilities. The need for very early identification of a fire or precursor event is of great importance in telecommunications equipment areas, and the need for earliest detection can be readily served by aspirating smoke detection systems. In cases where any of the noted fire suppression systems are installed in the data centre space, there is an equally important need to identify and investigate an alert or alarm condition prior to a suppression system operation – whether needed or not. A side effect of some suppression system operations (gaseous agent systems), is the need to partially or completely shut-down air handling equipment and close airflow dampers to contain suppressants. Such a shut-down can result in significant temperature rise in the equipment spaces, as well as the disruption of electronics. Therefore, early staff response initiated by an aspirating smoke detection system can result in confirmation to abort suppression system operation and any associated air handling shut-down. Conversely, an early staff response can result in manual fire suppression intervention or de-powering a section of equipment that appears as an ignition or fire source.

As previously mentioned, small and slow-developing telecommunications fires are attributable to the use of equipment and cables with high fire resistance characteristics. However, this may not be the always be the case: the need for suppression systems and capable smoke management systems becomes most important when the fire risks fall outside these controlling/limiting fire characteristics. However, fire suppression systems and smoke management systems don't diminish the need for an aspirating smoke detection system in a high-risk telecommunication environment. The early detection capabilities of aspirating smoke detection systems are important to staff response, smoke management system operations and potentially critically needed de-powering activities.

Design Best Practices

Two documents address the sensitive electronics environment in telecommunications facilities: BS 6266 (Fire Protection for Electronic Equipment Installations – Code of Practice) and the National Fire Protection Association standard (NFPA 76, Standard for the Fire Protection of Telecommunications Facilities). BS 6266 is intended to apply to a wide variety of environments using electronic equipment, including telecommunications switching/transmission systems. NFPA 76 is more specifically focused on buildings that house telecommunication equipment used in the transmission of voice/data/signals for the general public (i.e., central offices, public exchanges).

In terms of best practices, the telecommunication industry in North America has developed standards for equipment, protection, and emergency procedures that have recently been adapted and refined into the NFPA 76 document, Standard for the Fire Protection of Telecommunications Facilities. NFPA 76 requires that a fire protection program be established for telecom facilities based on the risks and hazards to the occupants, facility, and operations. It also expresses the criticality of telecommunication services, business continuity/disaster recovery plans, and protection strategies for minimising service disruption. A fire protection program may be established for a telecommunication facility by using any one of three methods (or a combination thereof):

- A performance-based analysis approach accounting for the site specific conditions and meeting established goals, objectives, and performance criteria
- Application of the prescriptive requirements and specifications for fire protection in NFPA 76
- Use of redundant facilities/services or plans for rapid facility/equipment replacement

Although the use of aspirating smoke detection technology would be expected to play a role in any performance-based approach, guidance on this subject is beyond the scope of this guide. However, further guidance is available in NFPA 76 (chapter on Performance-based Approach), and the SFPE Engineering Guide to Performance based Fire Protection. The more common basis for fire detection and aspirating smoke detection applications in telecommunication facilities are the prescribed requirements of NFPA 76.

When using NFPA 76, follow the four basic steps below to determine where fire/smoke detection is required and which type is required. Although the NFPA 76 minimum requirements will allow for various types of detection technologies, aspirating smoke detection can serve the needs of most any space in a telecommunications facility. Follow the steps below to determine the requirements for fire/smoke detection, including aspirating smoke detection systems.

- 1. Step 1** – Identify the physical boundaries that define the telecommunications facility. Typically, this will be the exterior walls of an isolated or standalone central office or public exchange building. In the case of a multiple tenant or multi-occupancy building, the telecommunications facility should be that portion of the building separated from other tenants or occupancies, as follows:
 - Separated by a minimum of two-hour fire resistant construction when the building is not under the ownership /control of the telecommunications tenant
 - Separated by a minimum of one-hour fire resistant construction when a mixed occupancy building is under the ownership /control of the telecommunications company

- 2. Step 2** – Determine the total area of signal-processing equipment (SPE) in the telecommunication facility to determine if the SPE occupies more than 232 m² (2,500 ft.²) or if the SPE occupies an area equal to or less than 232 m² (2,500 ft.²). The fire protection requirements will vary based on the total area of SPE on all floors in the telecommunications facility, relative to the 232 m² (2,500 ft.²) threshold.

Signal-processing equipment (SPE) includes, but is not limited to, switch and transport/access equipment, servers, routers, computers, and cable television equipment forming one-way or two-way communications links. When measuring to determine the total aggregate SPE floor area, keep in mind the NFPA 76 definition. NFPA 76 defines the SPE area as that area occupied by the SPE, including the access aisles between equipment and a 0.6 m (2 ft.) wide access zone around the perimeter of the SPE. Figure 3 below illustrates this calculation.

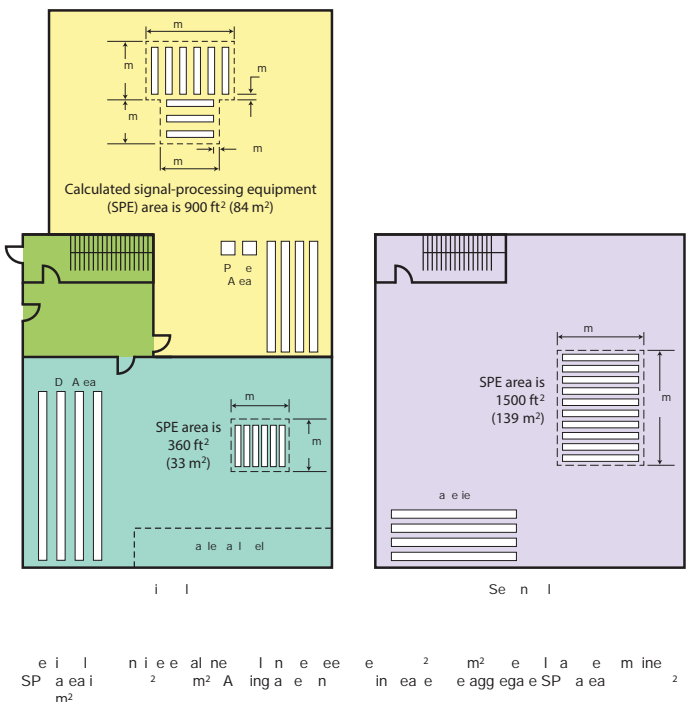

Figure 3 – Determination of SPE area

- 3. Step 3** – For each single enclosed room in the telecommunications facility, identify from the following list the hazard area(s) or equipment present and then provide fire /smoke detection as required per Chapter 6 of NFPA 76. Table 1 on the following page, summarises these Chapter 6 requirements. If any of the first six listed rooms/equipment areas are located within the same enclosed room, the most restrictive fire/smoke detection requirements are applicable to the entire enclosed room.

- 1). Heating, ventilating, and air-conditioning (HVAC) equipment installed to provide environmental control dedicated to the telecommunications equipment or telecommunications equipment areas
- 2). Signal-processing equipment areas
- 3). Cable entrance facility/equipment areas
- 4). Power areas or power equipment
- 5). Main distribution frame areas or main distribution frame equipment
- 6). Technical support areas
- 7). Standby Engine area (typically confined to room alone)

Table 1 - Summary of Minimum Requirements of NFPA 76 for Fire/Smoke Detection in Telecommunication Equipment Areas

Aspirating Smoke Detection Technologies can provide VEWFD, EWFD or SFD detection capabilities to match or exceed minimum NFPA 76 requirements

	SPE aggregate area > 2500 ft ² (232 m ²)	SPE aggregate area ≤ 2500 ft ² (232 m ²)
Signal-Processing Equipment (SPE)		
Room/area detection	VEWFD	EWFD
Raised floors with combustibles – No common airflow above and below	EWFD below floor	EWFD
Raised floors with combustibles - common airflow above and below	VEWFD above floor (room/area detection)	EWFD
Cable Entrance Facility	EWFD	EWFD
Power Areas/Equipment	EWFD	EWFD
Main Distribution Frame Area (MDF)		
Room/area detection	VEWFD	EWFD
Raised floors with combustibles – No common airflow above and below	EWFD below floor	EWFD
Raised floors with combustibles - common airflow above and below	VEWFD above floor (room/area detection)	EWFD
Standby Engine Area	Heat or flame detection	Heat or flame detection
Technical Support Areas (TSA)		
TSA not part of telecommunications equipment area	SFD per NFPA 72	SFD per NFPA 72
TSA contiguous with SPE or MDF areas	VEWFD	See below
TSA contiguous with power areas	EWFD	See below
TSA part of telecommunications equipment area when SPE area ≤232 m ² (2,500 ft ²)	Not Applicable	EWFD
HVAC Systems		
If VEWFD is required for the space (see above) then provide VEWFD as noted in next column	VEWFD ports to monitor return air; VEWFD ports to monitor returns of stand-alone packaged HVAC units	Not applicable

4. Step 4 – When selecting aspirating smoke detection technology to meet the requirements of NFPA 76, apply the parameters for VEWFD, EWFD, or SFD detection capabilities to match or exceed minimum NFPA 76 requirements as follows (also, see Figures 4, 5, 6, and 7 on the following page):

Very Early Warning Fire Detection (VEWFD) systems – detects low energy fires prior to the development of fire conditions that are threatening to telecommunications service. Minimum criteria applicable to aspirating systems are:

- Sampling port maximum coverage area: 18.6 m² (200 ft²); where two levels of air sampling ports are used, each level limited to a coverage of 37.2 m² (400 ft²) as illustrated in Figure 7 below right.
- Minimum sensitivity settings (effective at each port):
- Alert condition at 0.66 %/m (0.2 %/ft.) obs
- Alarm condition at 3.3 %/m (1.0 %/ft.) obs
- Maximum transport time: 60 secs.

Early Warning Fire Detection (EWFD) systems – detection by smoke, heat, or flame detectors before high heat conditions threaten human life or cause significant damage to telecommunications service. Minimum criteria applicable to aspirating systems are:

- Sampling port maximum coverage area: 37.2 m² (400 ft.²)
- Minimum sensitivity settings (effective at each port):
- Alert condition – no requirement
- Alarm condition at 4.9 %/m (1.5 %/ft.) obs
- Maximum transport time: 90 secs.

Standard Fire Detection (SFD) systems – systems that use fire detection initiating devices to achieve life safety and property protection in accordance with applicable standards. Automatic fire detection devices addressed in NFPA 72 are applicable for SFD systems.

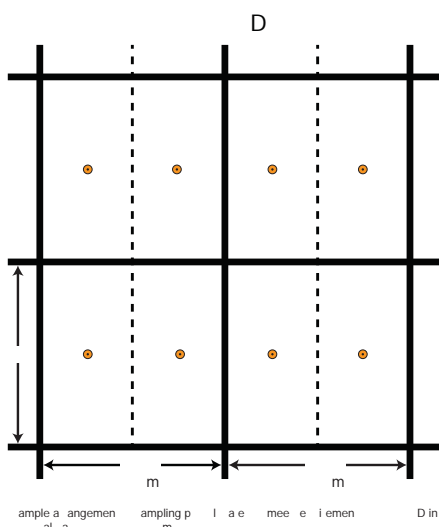

Figure 4. - Example of VEWFD Coverage

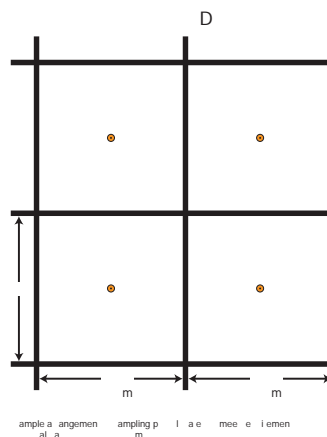

Figure 5. - Example of EWFD Coverage

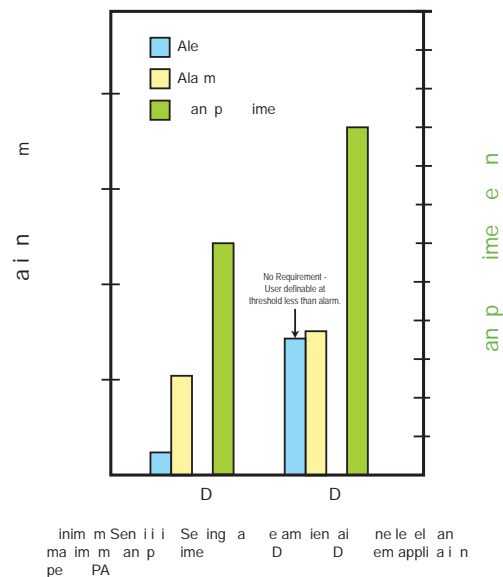

Figure 6. – NFPA 76 criteria for VEWFD and EWFD

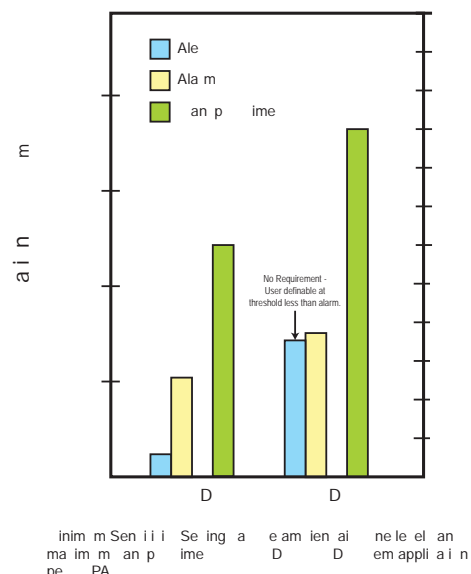

Figure 7. – Staggered VEWFD Coverage

In Europe, BS 6266 (Fire Protection for Electronic Equipment Installations – Code of Practice), is a best practice document applicable to electronic equipment installations including telecommunications facilities (public exchanges).

BS 6266 provides guidance on the structural fire protection measures, early detection concepts, fire suppression concepts, and fire safety management procedures that may be needed to minimise the potential consequences of a fire in electronic equipment environments.

BS 6266 requires a risk assessment prior to establishing the final design of electronic equipment installation. This involves considerations of the building and environment in which the equipment will be sited, and the proposed design of the fire protection systems. The criticality of the electronic equipment is an important factor in this risk assessment process. BS 6266 states that electronic equipment risks should be based on the following factors and classified as medium, high, or critical risks:

- Equipment redundancy and replacement availability
- Business continuity plans
- Tolerance to system downtime
- Environmental operational requirements specific to an individual system

Telecommunication equipment spaces, such as those found in central offices/public exchanges, would generally be expected to fall into the classification of high or critical risk, as defined by BS 6266, when one or more of the listed characteristics apply.

High category risk (BS 6266)

- a) Equipment is non-standard and is not replaceable in the short term
- b) Operations are not easily transferable without robust contingency plans
- c) There is a need for files to be backed up frequently on a remote server
- d) Interruption to business operations is likely to have serious consequences

Critical category risk (BS 6266)

- a) Equipment is high value or purpose-built and is not easily replaceable
- b) Operations are not easily transferable
- c) There is a need for data to be backed up on a continual basis on a remote server
- d) Interruption to business operations is likely to have serious consequences

BS 6266 recognises all types of smoke and fire detection systems; however, for the high and critical risk categories, BS 6266 recommends only the highest sensitivity smoke detection technologies that can meet the test fire requirements of EN54-20 to provide the earliest possible indication of fire. Aspirating detection technology provides such capability, and BS 6266 recognises EN54-20 Class A aspirating smoke detection systems as an appropriate technology for use.

BS 6266 specifically notes that the cumulative effect associated with aspirating smoke detection systems makes them particularly appropriated for detecting smoke that is diluted through a space. The following factors should be taken into consideration when designing air sampling smoke detection systems.

- a) Electronic equipment areas are continually increasing their power handling capability, which means that the air-conditioning systems serving the spaces require increased airflow and velocities
- b) Positioning of sampling points is critical due to the very high airflows in the room. While an even distribution of devices is often assumed to be preferred, strategic positioning can be advantageous in many cases
- c) High velocity airflow through plenum voids necessitates detectors being placed in advantageous positions to detect any smoke
- d) Hot or cold aisle containment – where physical partitioning is introduced between the cabinet air entry (cold aisle) and the air exit (hot aisle) – creates a further enclosure within the space, effectively an extension of the floor (or ceiling) plenum, which needs appropriate detection
- e) The detection strategy needs to be clearly defined in relation to the air flows and cooling requirements in the area, particularly whether the air-conditioning is to remain operational or shut down after the first alarm signal to facilitate confirmation of the alarm by a detection system at the ceiling and/or to prepare the area for activation of automatic suppression
- f) The operational procedures, the expected number of personnel in the area, and the time required for competent action to commence will determine the strategy for alarm and warning signals. Generally, the automatic fire alarm system should operate alarms within the electronic equipment area and in other areas where action is to be taken

When applying BS 6266, the intended sensitivity of an aspirating smoke detector should be specified by properly identifying the class required (Class A, B, or C per EN 54-20:2006). The class of an aspirating detector relates to the sensitivity of the sampling holes, not the detection unit sensitivity. BS 6266 specifies EN 54-20 Class A, B, and C air sampling detection to be implemented as follows:

- When used to detect smoke in the return airflow from the room, a Class A system should be used to provide early warning
- When used to detect smoke within a cabinet or enclosure, a Class A or B system should be used to provide early warning
- When used to detect smoke at the ceiling of the room or within a floor or ceiling void, a Class A or B system should be used when the air-conditioning is to remain operational. A Class C system can be used when the air-conditioning can be shut down.
- The general spacing of air sampling ports for ceiling detection or void spaces greater than 1.5 m (4.9 ft.) deep is 25 m² (269 ft.²). BS 6266, however, stipulates that adjustments are to be made based upon considerations for airflow, sensitivity, equipment operational factors, etc., that are detailed in Annex 1. The total adjustments possible can result in coverage areas as small as 5 m² (54 ft.²) and as large as 55 m² (592 ft.²).

Airflow Considerations

As a result of concentrated heat loads from electronic equipment in telecommunications facilities, significant airflows are needed to keep equipment within proper operating temperature ranges. To accomplish this, large air flows are provided with the basic objective of supplying cool supply air to the equipment and moving hot exhaust air away from the equipment. Standard smoke detectors are generally not capable of performing in high airflows. Because of room air currents dilution and stratification phenomenon, sufficient smoke may not be able to reach a ceiling-mounted detector; if smoke can penetrate to a ceiling-mounted

detector, then there may not be a sufficient quantity of smoke to activate a standard smoke detector. NFPA 72 specifies that smoke detectors should not be used in airflow environments over 1.54 m/s (300 fpm), unless the devices are specifically recognised for such conditions.

NFPA 72's typical spacing requirements are 84 m² (900 ft.²) for standard smoke detectors in normal airflow environments are. However, both BS 6266 and NFPA 72 recognise these smoke detection challenges and stipulate spacing reductions in for detection points in such high airflow conditions. NFPA 76 directly accounts for these airflow conditions and requires reduced smoke detection/sampling port spacing of 18.6 m² (200 ft.²) or 37.2 m² (400 ft.²) for various telecommunications equipment areas.

Similarly, BS 6266 provides guidance specific to adjustments needed in electronic equipment installations based on airflow. The BS 6266 standard spacing of sampling ports for ceiling detection is 25 m² (269 ft.²), which is to be reduced by 5% or 10% when airflows greater than 1m/s or 4 m/s, respectively, are present in an area greater than 25% of the space where the detectors are located. An aspirating smoke detector can provide detection at very low particle levels and in high airflow environments. Consider that a standard spot smoke detector operates in the range of 4.8 -9.7% obs/m (1.5 - 3.0% obs/ft.), and an aspirating detection system can be programmed to provide sensitivity for detection as low as 0.0015% obscuration/m (0.00046% obs/ft.). Aspirating smoke detection systems are up to the challenge of the high airflow environments of telecommunication facilities, with the capability of detection in 20.3m/s (4,000 fpm) environments.

Both BS 6266 and NFPA 76 place an emphasis on the use of highly sensitive smoke detection for the airflow return paths in electrical equipment environments. BS 6266 allows a Class A aspirating detection system in the air return to a HVAC/CRAC system to be the sole means of detection, if the air conditioning equipment has appropriate back-up power systems and is essential for assuring 24/7 operations of the electronics equipment. NFPA 76, Chapter 6 provisions require that SPE areas and main distribution

frame areas use VEWF sampling ports to monitor the return air to HVAC systems for telecommunications environments.

Common HVAC equipment is often provided as standalone, packaged units known as CRAC units (computer room air conditioner units). These air conditioning units monitor and maintain the temperature, air distribution, and humidity in telecommunications equipment rooms.

Identify and Understand the Airflow Management Scheme

There are numerous approaches to air distribution and equipment cooling in telecommunications equipment areas. Understanding the approach applied in any given facility will allow the designer to identify the key air return flow paths, as well as areas where airflow is minimal and unlikely to carry smoke particulate to a sampling port location. Figure 8 below shows the basic placement of air sampling port locations typically encountered in a telecommunications equipment area, using a hot and cold aisle air management concept.

Distributing air in a telecommunications equipment area usually involves one or more of three basic approaches:

- **Flooded** – the flooded approach uses a supply and return air distribution system in which the only airflow constraints are the room's physical boundaries (walls, ceiling, and floor). Due to the extent of hot and cool air mixing, sampling points are recommended at the ceiling return grills and/or at the HVAC/CRAC unit air returns
- **Targeted** – the targeted approach also uses a supply and return air distribution system; however, the supply or return is placed near or adjacent to the electronic equipment through the use of ducts, perforated tiles, or even a piece of localised equipment within the racks, in an effort to direct the airflow to/from the equipment. Ceiling sampling points are recommended for this configuration. The airflow pattern is more predictable, and hot air returns (such as ducts or plenum spaces

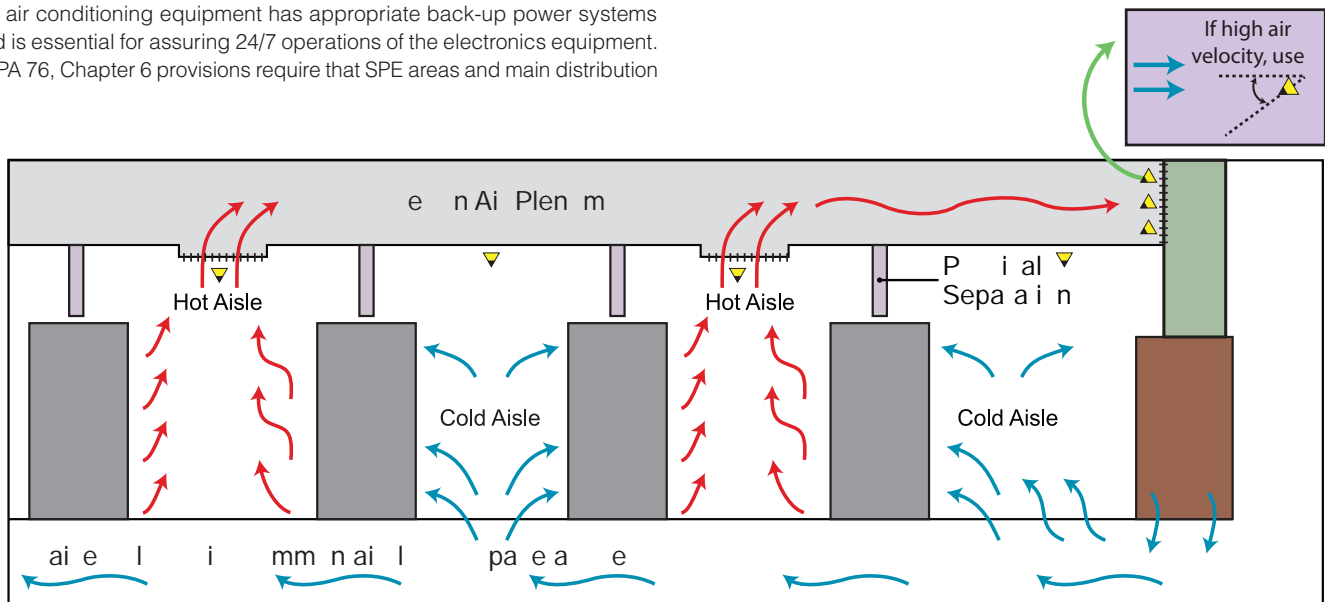

Figure 8. – Example of air sampling port locations in a Signal Processing Equipment (SPE) Area

or the returns to a CRAC unit) are key areas for placement of sampling points

- **Contained** - the contained approach also uses a supply and return air distribution system, where the telecommunications equipment supply and/or return airflow is completely or partially enclosed to minimise or eliminate air mixing. These contained approaches are also known as hot aisle/cold aisle configurations. Ceiling sampling points are recommended for fire sources outside of IT cabinets. The hot aisle/cold aisle containment area, the hot air return ducts, or the interior of the equipment cabinets are areas for placement of sampling points.

Figures 9-13 below and to the right, illustrate the concepts of flooded, targeted, and contained air flow arrangements found in telecommunications equipment areas and the locations that should be used for air return monitoring (when required). The flooded and target approaches have been traditional approaches, but the contained approaches using hot and cold aisle designs are now used often for energy efficiency and cooling effectiveness.

Coordination and Interface with other Systems

Fire Protection Systems: fire protection systems in telecommunications facilities may be implemented in a number of ways:

- Automatic sprinkler systems only
 - Wet systems
 - Pre-action – non-interlocked, single interlocked, double interlocked
- Automatic sprinkler systems with supplemental clean agent systems
- Water mist systems only
- Water mist systems with supplemental clean agent systems.
- Clean agent systems only.

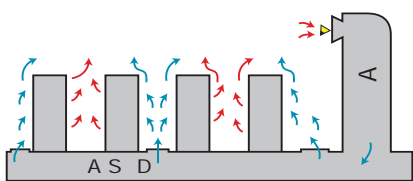

A targeted air supply with a flooded return air system. Cold supply air mixes with hot return air. Install air sampling ports at main return into HVAC/CRAC unit.

Figure 9. – Return air monitoring for Targeted supply, flooded return

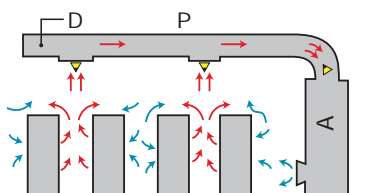

A flooded supply with a targeted air return scheme. Hot air can mix with cold air supply. Two options to monitor return air: 1) Provide ports at duct return grills, or 2) at main return into HVAC/CRAC unit.

Figure 10. – Return air monitoring for flooded supply, ducted/plenum return

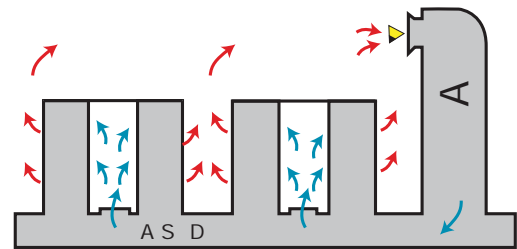

Contained supply air (cold aisle). Flooded hot air return. Install air sampling ports at main return into HVAC/CRAC unit.

Figure 11. – Return air monitoring for contained supply, flooded return

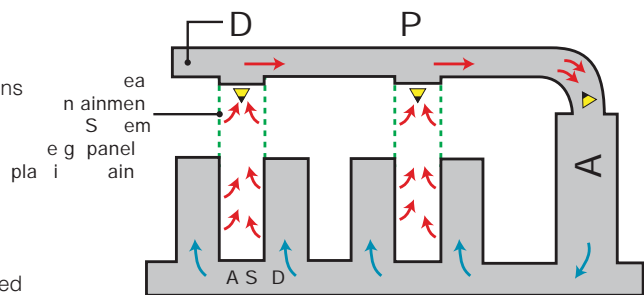

Contained supply air direct to electronic cabinets. Hot air return through heat containment system.

Two options to monitor return air:

- 1) Provide ports at duct return grills, or
- 2) at main return into HVAC/CRAC unit.

Figure 12. – Return air monitoring with heat containment system in place

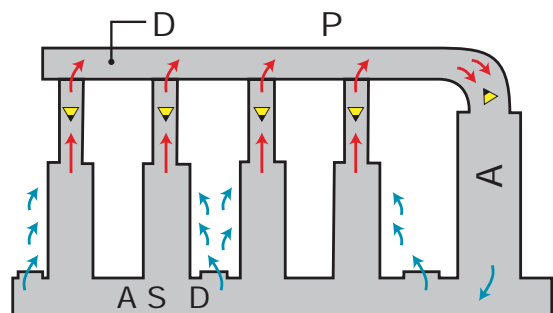

Targeted supply air with contained hot exhaust air capture. Two options to monitor return air: 1) Provide ports in exhaust collars, or 2) at main return into CRAC unit.

Figure 13. – Return air monitoring with hot exhaust collars

Often the implementation and choice of systems is related to owner/operator concerns for water damage to equipment. The NFPA 76 guidance is to avoid water-based systems in the power areas, standby engine room, MDF areas, and SPE areas. Depending on the fire protection system(s) used, there's typically a need for a fire detection system interface to initiate sprinkler pre-action valve operations, damper closing operations prior to clean agent release, or shut-down of HVAC systems and de-powering of equipment. Aspirating detection can play an important role in these operations by providing alert indications and alarms at appropriately set smoke detection levels. Early staff response initiated by alert and action settings of an aspirating smoke detection system can result in confirmation of the need for aborting extinguishing system operation and any associated air handling shut-down. However, the typical Fire 1 and Fire 2 alarm setting can be programmed to initiate pre-action valve release or clean agent release if a threatening fire is in development. Where a sprinkler or water mist system is supplemented by a clean agent system, there may be a desire to either control suppression/extinguishing system operations with two alarm levels of an aspirating detector (i.e., Fire Alarm 1 and Fire Alarm 2), or use two independent detection systems. For example, an aspirating detector may be used for sprinkler pre-action valve control, while a second detection system is used for clean agent release after an appropriate time delay period (e.g., 30 seconds). Alternatively, a Fire Alarm 1 Level may be used for sprinkler pre-action valve control and the Fire Alarm 2 Level used for clean agent release. Aspirating systems provide the early response needed to initiate an extinguishing system in the event of a developing fire. Quick water application and system effectiveness is typically improved by early operations during the fire event: aspirating systems provide this capability to assure prompt extinguishing system action.

HVAC Systems and De-powering Operations: Electrical power supplies in telecommunications facilities are designed to keep equipment operating throughout the duration of a fire, which is usually limited in area and slow burning. The emergency communications routed through central office/public exchanges are critical to public safety, and it's considered inappropriate to de-power an entire facility except for extreme cases. De-powering is generally accomplished using only manual power disconnect features. Aspirating smoke detection can be valuable to the sequence of de-powering operations, because prematurely shutting down HVAC can cause an immediate temperature spike in the facility and result in damage to the electronics equipment. Early staff response initiated by an aspirating smoke detection system's alert and action settings can confirm the need for any associated air handling shut-down or initiation of smoke management sequences. Also, should an actual fire event transpire, the typical Fire 1 and Fire 2 alarm settings can be programmed to initiate pre-action valve release, clean agent release, or smoke management systems used to remove smoke and prevent it from spreading to other areas of the facility.

Common Issues/Application Troubleshooting

Aspirating smoke detection has many benefits, and the remote sensor programmability makes it a suitable detection system for a data centre. However, there are several considerations for the use of aspirating smoke detection within data centres. During the design phase, consider the following factors should:

- The designer needs to verify the airflow and its direction within the space to maximise the system's effectiveness. The sampling points should be installed in the direction of the airflow

- For a large detection system with many sampling holes, the designer needs to take smoke/air dilution into account. A greater volume of air returns to the aspirating smoke detector with the more sampling holes the pipe contains, which could delay the time it takes to initiate the alarm within the detection chamber
- The location of the sampling holes within the detection network is a concern. The further the sampling hole is located from the aspirating smoke detector, the more air/smoke dilution occurs, which could delay the time the quantity of smoke necessary to initiate an alarm is present within the detection chamber
- In normal applications, it is common for the air pressure in the protected room (PR) to be the same as the air pressure where the air is being exhausted from the detector (PE). The design software that is used to calculate transport times and detector sensitivities assumes equal air pressure in the two spaces. The sampling hole size, pipe size, transport time, and the fan aspirator speed are all functions of the air volume that passes through the sampling chamber. The sensing chamber is designed to detect smoke particles moving through the chamber at the speed of the fan. If PR is greater than PE, the velocities of the sampled air entering the chamber could be higher than the nominal fan speed, which could directly impact the detector's ability to sense smoke particles. Conversely, if PE is greater than PR, air pressure builds on the exhaust air, causing resistance and a drag on the fan. As a result, the fan may operate slower than designed, causing an increase in transport times and less air going into the sensing chamber. To eliminate the pressure difference, the exhaust air needs to be piped into the same room that is being sampled

During the commissioning process, the installing contractor needs to properly program the alarm thresholds and sensitivity levels because both could significantly impact the aspirating smoke detector's performance. The following programming considerations should be considered:

- Typically, aspirating smoke detectors are shipped with default settings from the factory. These generic settings are not appropriate for all detection systems because they may be either too sensitive or not sensitive enough for a specific application. It is necessary for the aspirating system designer to determine the alarm levels and program the sensor accordingly. The sensitivity levels and alarm thresholds are derived by a combination of the computer-based calculation program, the hazard being protected, detection system size and engineering judgment
- The programmable sensitivity levels are another significant issue impacting the performance of aspirating smoke detection systems. The detectors contain sophisticated electronics and software that allow the device to be programmed to a wide range of sensitivity levels. If these alarm levels are not programmed properly, then the quantity of smoke necessary within the sensing chamber may exceed the desired sensitivity and cause a delay in alarm signal initiation.

Time delays for trouble and alarm signal activation are also included at the detector. These delays can be set for a range of times, but typically span from 10 - 30 seconds. Consideration should be given when programming the time delays. The greater the delay, the longer it will take for the detector to initiate an alarm signal.

Dos

- Identify applicable codes and insurer's requirements
- When NFPA 76, Standard for the Fire Protection of Telecommunications Facilities, applies the following is recommended
 - Determine which approach of NFPA 76 is being applied: performance-based approach, prescriptive approach, or a redundant facilities equipment approach
 - Review the risk and hazards of the facility with the telecommunications service provider and all recommendations for automatic smoke detection
 - Using a NFPA 76 prescriptive approach, apply aspirating smoke detection when VEWF or EWFD smoke detection is required for 1) the ceiling level throughout the telecommunications equipment areas, and 2) below the raised floors containing combustibles when airflow is not common with the space above and below the raised floor
 - Using a NFPA 76 prescriptive approach, apply VEWF sampling ports at a coverage area not exceeding 18.6 m² (200 ft.²) and EWFD sampling ports at a coverage area not exceeding 37.2 m² (400 ft.²)
 - Using a NFPA 76 prescriptive approach, apply VEWF air sampling points to monitor return air from those spaces require VEWF systems. Provide sampling ports to monitor HVAC/ CRAC air returns. Arrange the ports so that each covers no more than 0.4 m² (4 ft.²) of the return opening
 - Consider sampling ports both under cable trays and at the ceiling, when cable tray density and arrangement are sufficient to impede smoke flowing to the ceiling
 - Assure that alarm and trouble signals from aspirating smoke detection systems are annunciated at a constantly attended location
 - Confirm and implement how alert and fire alarm settings are to be integrated to initiate the following if applicable: 1) power shut-down (typically a manual operation in telecommunications facilities), 2) pre-action system valve operation, 3) gaseous agent release, 4) water mist system release, 5) air handling shut-down and associated damper or door closures, 6) initiation of smoke management/control system, 7) release of aisle air flow containment systems (e.g., vinyl curtains) ,that present an obstruction to agent delivery from sprinkler or gaseous agent systems.
- When BS 6266 (Fire Protection for Electronic Equipment Installations – Code of Practice), applies the following is recommended:
 - Review the documented risk assessment for the electronic equipment areas and understand which areas classify as medium, high, or critical risk electronic installations
 - Identify where Class C, aspirating type smoke detection is to be applied.
 - Identify where Class B, aspirating type smoke detection is to be applied. Class B systems are used when increased sensitivity is needed to compensate for dilution effects due to high ceilings or moving airflows
 - Identify where Class A, aspirating type smoke detection is to be applied. Class A systems are used in area having high air movement and smoke dilution or where the very earliest warning is needed to protect critical business operations, high value data processing or high value electronic equipment
 - Install sampling holes for optimum effectiveness in accordance with Annex A provisions of BS 6266 for air return vents, ceilings, below-floor and above-ceiling void spaces, in-cabinet locations, and proximity to air inlets and ceiling fittings
 - Apply the rules of BS 6266 where aspirating type smoke detection is applied.
 - Confirm and implement how alert and fire alarm settings are to be integrated to initiate the following if applicable: 1) power shut-down (typically a manual operation in telecommunications facilities), 2) pre-action system valve operation, 3) gaseous agent release, 4) water mist system release, 5) air handling shut-down and associated damper or door closures, 6) initiation of smoke management/control system, 7) release of aisle air flow containment systems (e.g., vinyl curtains), that present an obstruction to agent delivery from sprinkler or gaseous agent systems

Don'ts

- Don't exceed the recommended detector or sampling point spacing of applicable standards or insurance carrier requirements
- Don't use detectors that are not listed or approved for air velocities and temperatures that will be encountered in the IT areas or equipment
- Don't design the aspirating smoke detection system to exceed the transport time requirements of installation standards or insurance company requirements
- Don't install ceiling sampling points too near to ceiling supply air diffusers. Maintain a distance of 0.9 m - 3 m (3 ft. -10 ft.) from ceiling diffusers, depending on the strength of the airflow. (See BS 6566 and NFPA 72 for specific requirements)

Section 7

Duct and Return Air Monitoring

Application

The primary purpose of a duct smoke detection system is to “Detect and Prevent” the migration and spread of smoke through a building’s HVAC system. The installation of duct smoke detectors is not a substitute for an area smoke detection system, but it can significantly minimise the migration of smoke within a building.

A traditional duct smoke detection system consists of spot-type smoke detectors mounted on the side of the duct and a sampling tube that extends into the duct. Some applications require a greater level of sensitivity than that provided by traditional spot-type duct smoke detectors. Typical prerequisites of enhanced duct smoke detection system may include:

- Early warning is required to allow for evacuation of occupants
- Early warning is necessary because the smallest amount of smoke could damage equipment within the space (in telecommunication or data centres, for example)
- High-airflow environments may require advanced, sensitive detection that traditional spot-type detectors couldn't provide

Unlike traditional duct smoke detectors, ASDs offer active sampling as well as a higher level of sensitivity and programmability to reduce nuisance alarms, which makes them an extremely sensitive alternative.

ASDs are also effective in areas with high air exchange; such environments typically require mechanical ventilation to maintain constant or cyclical air flow for heating, cooling, and dust filtration. Smoke tends to travel with the air flow, so positioning sampling pipes near the return of an air handling unit, heating/air conditioning unit, or return air grill ensures early detection of particulate in the area.

Benefits of ASD

The benefits of active duct sampling come with additional challenges. ASDs are required to monitor and maintain a minimum airflow volume; when operating inside ductwork, this can significantly test the ASD’s capabilities because air speeds not only vary from duct to duct, but they also vary within a duct. Use caution if ASDs are installed as duct-mounted smoke detectors.

Best Design Practices

Many ASDs are approved for in-duct applications; however, it’s necessary to confirm the ASD is listed for duct applications prior to installation (BS EN 54-27 and UL 268A).

Basic Design Considerations for In-Duct Sampling

Follow these guidelines to obtain the best installation results for the inlet pipe (sampling pipe). See Figure 1 to the right for typical installation.

- Pipe should always be supported at both duct walls. Rubber grommets can be used for support for most plastic and light weight pipes. If metal pipes are used, more sturdy supports may be necessary
- Silicon sealer must be used to ensure an airtight seal in the duct walls
- Inlet pipes must be inserted between six and ten duct widths or diameters (for round ducts), from any disturbances to the flow generated by sharp bends, plenums, nozzles, and branch connections

- For European installations: the Fire Industry Association (FIA) Code of Practice for Design, Installation, Commissioning & Maintenance of Duct Smoke Detector (DSD) Systems, requires the sampling pipe to be inserted a minimum of three duct widths from a bend.
- Sampling holes should be located no closer than 51 mm (2 in.) to the duct wall
- Sampling holes on the inlet pipe should face 20° - 45° into the air flow, with the holes concentrated at the centre of the duct (as shown in Figure 1 below)
- For maintenance test convenience, a test sample point can be installed externally to the duct. The test point would be installed in the sampling pipe and remain closed during ASD normal operation

The Exhaust Pipe

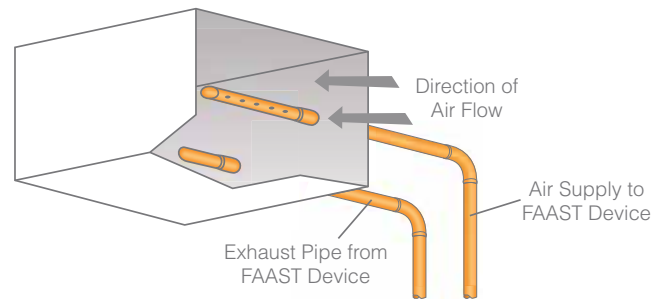

Figure 1. Design consideration for in-duct sampling

- The exhaust pipe must have four holes drilled (see manufacturer’s recommendations for specific hole size); the holes should be concentrated in the middle of the duct’s width and spaced evenly. Holes on the exhaust pipe should be oriented so they face away from the airflow
- The exhaust pipe should be located approximately 0.5 m (18 ft.) downstream from the inlet pipe
- The exhaust pipe should be inserted into the duct at a height equal to 1/4 of the duct height (H/4)
- The exhaust pipe may be set up in two different configurations:
 - The first option consists of a pipe with four holes and of the same length as the sampling pipe. Traditionally, fitting the exhaust pipe with holes has been the way to install ASDs in ducts. This configuration promotes somewhat more stability to the air passing through the detector with less overall sampling volume as a trade-off. When employing this configuration, it is recommended to position the exhaust holes directly away from the airflow.
 - A second option is installing a short pipe that protrudes 51 to 76 mm (2 - 3 in.), into the duct and is not fitted with an end cap. This is a simpler method and promotes better overall airflow through the detector. However, this arrangement may be more prone to faults caused by duct airflow fluctuations. It is recommended to try this configuration first and then revert to the traditional method if stabilising the airflow pendulum proves difficult.

Sampling Pipe Installation

After determining the proper number and sizes of sampling pipes and sampling holes, all pipe should be cut to the proper length and holes drilled. The ASD unit should be mounted to a nearby adjacent location and additional pipe run to the duct. Duct sampling pipe should be located at least six and ten duct widths from sharp bends or branch connections that may disturb the duct airflow. This will allow the airflow to become laminar before reaching the sampling pipe. Inlet and exhaust pipe holes should be cut into the duct work, at the appropriate location. With all pieces assembled, insert the inlet and exhaust pipes into the duct but do not seal or cement. Using the line marked on the sampling pipe, plan the sampling holes so they are facing into the airflow, and directed upwards at approximately 45°. After the inlet pipe and sampling holes are properly oriented, secure the pipes, seal the duct penetrations, and then install the remaining pipe and connect to the ASD unit.

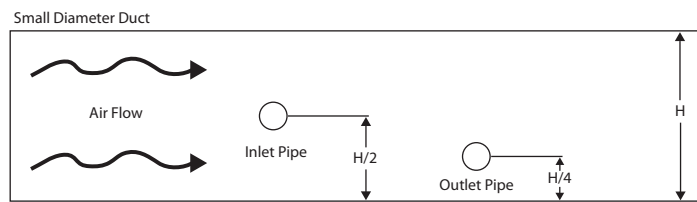

Figure 2. Small duct sampling locations

Table 1 – Small duct sampling hole quantity and size

Duct Width	Number of Sampling Holes Per Pipe	Hole Size	Nominal Pipe Flow Rate (CFM)
51 - 76 mm (12 in.)	2	6.5 mm (1/4 in.)	1.84 cfm (52.0 l/min.)
500 mm (20 in.)	3	6.5 mm (1/4 in.)	1.83 cfm (51.9 l/min.)
700 mm (28 in.)	4	4.5 mm (11/64 in.)	1.70 cfm (48.1 l/min.)
900 mm (36 in.)	5	4 mm (5/32 in.)	1.81 cfm (51.2 l/min.)

Large Horizontal Ducts

A large duct (See Table 2) is any duct that has a width of 1 m - 2 m (3 ft. - 7 ft.). Two branch pipes are recommended for the inlets of these ducts. The inlet pipes should enter a quarter of the way from the top and bottom of the duct, as shown in Figure 3 below. The exhaust pipe should be inserted approximately 0.5 m (18 in.) from the inlet pipes and halfway up the height of the duct. To avoid dilution, sampling pipes should be located before fresh air intakes and before exhaust air output.

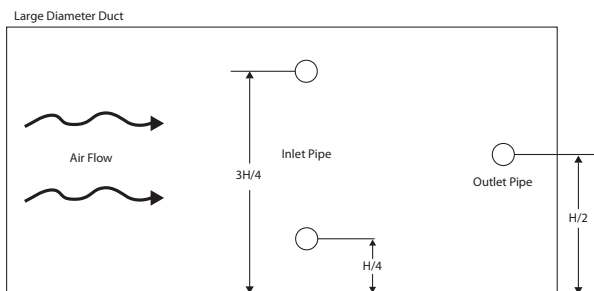

Figure 3. Large duct sampling locations

Table 2 – Large duct sampling hole quantity and size

Duct Width	Number of Sampling Holes Per Pipe	Hole Size	Nominal Pipe Flow Rate (CFM)
1 m (40 in.)	6	3.5 mm (9/64 in.)	1.77 cfm (50.2 l/min.)
1.5 m (5 ft.)	8	3 mm (1/8 in.)	1.80 cfm (50.9 l/min.)
2 m (6.5 ft.)	10	3 mm (1/8 in.)	2.10 cfm (59.6 l/min.)

The number of sampling holes and hole sizes outlined in Table 1 to the left and Table 2 above are for a 4.6 m (15 ft.) piping network and a 3 m (10 ft.) exhaust pipe. Before the sampling holes are drilled and the pipe is installed in the duct, confirm the hole spacing and sizes with the design software and manufacturer's recommendations.

For ducts over 1 m (3 ft.), the sampling pipe will need extra support. This can be accomplished by an external strut or a hole in the opposite wall of the duct.

Large Vertical Ducts

A large vertical duct is any duct that exceeds 1 m (3 ft.) in height, regardless of the width of the duct. The spacing and location of the sample pipe rows should be 1/#P(2) (P = sampling pipe) for the sample pipes closer to the wall of the duct, and 1/#P for the spacing of the sample rows in the middle of the system.

Three sampling pipes are required for the inlets of large vertical ducts. The inlet pipes should enter the duct as outlined in Figure 4 below, maintaining the following guidelines:

- An additional row of sample ports is required when the duct height exceeds 91.4 cm (36 in.), regardless of the width of the duct.
- When the system requires three rows of sampling pipes, the sampling hole sizes are determined by duct width in Table 1 and Table 2. For example, if the duct is 1,016 mm (40 in.) in height and 1,016 mm (40 in.) wide, then the duct would require three sampling pipes with six equally spaced sampling holes per pipe: all sized 3.5 mm (9/64 in.).
- Sample row spacing and location should be 1/#P(2) for the sample pipes closer to the wall

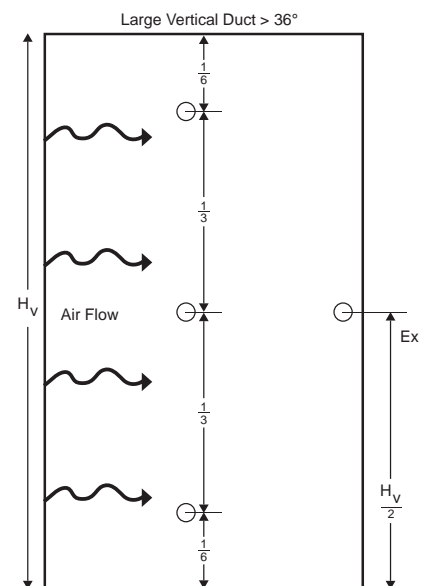

Figure 4. Large vertical ducts

of the duct, and 1/#P for the spacing of the sample rows in the middle of the system

- For large ducts, the sampling hole sizes should be confirmed using the manufacturer's design software

European ASD Duct Smoke Requirements

Local regulations require duct smoke detectors to initiate an alarm signal when the duct smoke concentration reaches approximately 13% obs/m.

EN54-20 requires ASD systems to be tested utilising four different test fires and initiate an alarm signal at the end-of-test (EOT) conditions to its specific Class. See Table 3 below for ASDs utilised as duct smoke detector requirements.

Table 3 – Summary of EOT conditions for test fires

	Level 1	Level 2	Level 3
EN54-20	Class C Normal	Class C Enhanced	Class 3 High
TF2 EOT	37% obs/m	3.4% obs/m	1.14%obs/m
TF3 EOT	37% obs/m	3.4% obs/m	1.14%obs/m
TF4 EOT	25-32% obs/m	n/a	n/a
TF5 EOT	19-25% obs/m	6.7% obs/m	2.3% obs/m

Return Air Monitoring

Normal sampling methods for high air exchange areas are a combination of return air and ceiling sampling. The return air sampling provides protection when the air flow is present, and the ceiling network provides protection when the air flow is off. Local codes typically require smaller sample areas (closer spacing of sample ports), as the air flow rate increases.

Return air sampling provides an effective means of Very Early Warning Detection (VEWD), in high air velocity environments.

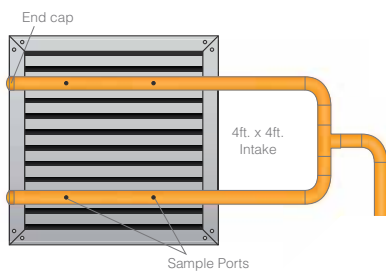

Figure 5. Piping installation on return air grill

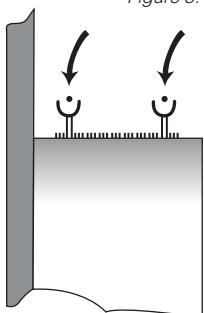

Figure 6. Piping installation on return air AHU

Placing the pipe network sampling ports directly in the air stream at the return air grill (see Figure 5 below left), duct, or on the air handler unit (AHU), allows the system to monitor the air that has circulated throughout the protected area (see Figure 6 below left). This is an extremely effective detection strategy for data centres, telecommunication centres, and clean rooms; as the air is conditioned, the majority will circulate or pass through the AHUs and grills and all the air within the room will eventually be sampled.

From Table 3 to the left, it is clear that Class A and Class B ASD system sensitivity is significantly higher than a traditional spot-type, duct-mounted smoke detector approved by EN54-27.

The following guidelines should be reviewed and followed to ensure proper detector system sampling:

- More than one sampling location may be required for large air grills. NFPA 76 recommendations specify that each sampling port can cover a maximum of 0.4 m² (4 ft.²)
- Sampling ports should be aligned at an angle of 20° - 45° to the direction of the maximum airflow (See Figure 7 below)
- Sampling pipes should be placed in the path of the greatest airflow
- The number of bends in the pipe network should be kept to a minimum
- Pipe ends should be capped with an end cap. Depending on the pipe design, the end caps may or may not have a sampling port
- Socket unions should be used in locations where the pipe network requires the removal of the pipes on a regular basis for maintenance purposes
- Use standoff fittings to keep the pipe network at least 50 mm - 200 mm (2 - 8 in.) in front of the grill or the AHU, for high velocity airflow locations. Installing the network any closer to the input grill or AHU locates the sample port in an area of negative air pressure
- Always keep in mind that the monitored environment should still ensure coverage even if the manufactured airflow gets disrupted

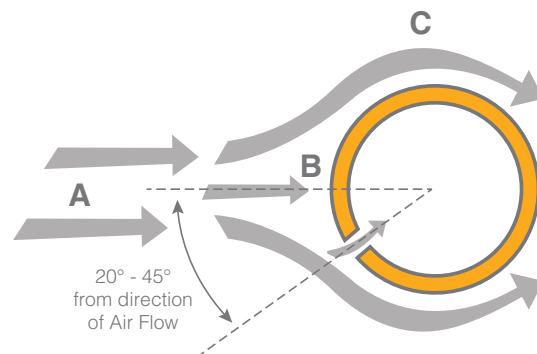

- A. Airflow Streamlines
- B. Low velocity (high static pressure) area
- C. High velocity (low static pressure) area

Figure 7. Sampling hole orientation

When monitoring multiple AHUs with ASD, the AHUs should have similar airflow at all times. The number of monitored AHUs is limited by the maximum length of the pipe network. However, the degree of particle dilution and air movement that occurs with multiple AHUs can adversely affect system response times.

Port Orientation

The sampling response time can be improved by avoiding high and low velocity airflows perpendicular to the sampling holes. Sampling holes on the duct inlet pipes, on return air grills, or on CRAC or HVAC units should be facing 20° - 45° from the where high velocity air will be passing over the sampling pipe (See Figure 7 on the previous page).

Common Issues/Application Troubleshooting

Nuisance flow faults are a common concern with ASD airflow. Airflow through the ASD is affected by two key factors: variable airflow through the duct and also the orientation of the sampling holes and exhaust port. Duct airflow caused by the AHU fan unit is beyond the control of the installation practices, but sampling hole orientation could significantly impact the flow through the ASD and reduce nuisance flow faults. To avoid nuisance flow faults, it is recommended to “tune the system.”

Tuning the System

With the air handling units off, power up the ASD. Then, connect to it using the computer-based software, set the desired configuration parameters, and reconfigure the device. If the ASD unit does not automatically reset after receiving a new configuration, power down the unit. After a brief start-up sequence, allow 5 minutes for the ASD to adjust to the new pipe network. Once 5 minutes have elapsed, turn on the air handling units, preferably at the highest velocity. Observe the real-time airflow data in the computer-based software.

If more air is needed in the ASD, carefully adjust the sampling pipe so that the holes are facing the oncoming airflow. A few degrees of rotation may have a significant impact. After making the adjustment, wait at least 20 - 30 seconds for the airflow to stabilise and the data to update.

If too much air is entering the ASD, carefully adjust the sampling pipe so the holes are facing away from the airflow. After making the adjustment, wait for the airflow to stabilise and the data to update. Continue adjusting as necessary until the airflow data remains in the desired range.

When satisfied with the sampling tube position, shut off the air handling units and observe the airflow data. It should remain at or near the desired airflow. When satisfied with the airflow, mark the angle of rotation on the duct and then complete the installation by sealing and securing the sampling tube as appropriate. Perform smoke testing as prescribed by the Authority Having Jurisdiction (AHJ).

Dos

- Verify the sampling holes are facing 20° - 40° to the direction of the airflow (See Figure 7 on the previous page for installation detail)
- Verify all sampling pipes and sampling holes are unobstructed
- Verify all the penetrations into the duct(s) are sealed properly and not leaking air
- Verify the sampling exhaust is piped back into the duct when the sampling pipe is installed. For exhaust pipe location, see Figure 2 for small ducts, Figure 3 for large ducts, and Figure 4 for large vertical ducts (all featured on page 40)

- The sampling pipe is installed on stand-offs that allow 50 mm - 200 mm (2 - 8 in.) in front of the grill
- Test the system to ensure that the detector sensitivity settings, alarm/trouble delays, and system shut-downs are designed and installed in accordance with the appropriate code and standard

Don'ts

- Orientate the sampling holes directly into the airflow
- For return air grill monitoring, do not mount the sampling pipe directly to the face of the grill

Section 8

Clean Rooms

Application Overview

Manufacturing industries and scientific research environments that require highly controlled air quality environments use the concept of clean rooms to protect against contamination. Contamination can result from dust, pollen, bacteria, aerosol particles, combustion particles, and chemical vapours. Humans in these work environments can introduce contaminants in the form of skin flakes, lint, cosmetics, and emissions due to human respiration. So from a more technical perspective, a clean room is an airborne-particle controlled environment containing one or more clean zones (areas that meet a specified airborne particulate cleanliness class). The specified airborne particulate cleanliness classes have been defined by ISO standard 14644-1 and the US federal standard (US FED STD) 209E. The classification systems address how few particles, measured in microns, occupy a fixed volume of air (a one-micron particle is one-thousandth of a millimetre, or 39 millionths of an inch).. For comparison, a human hair is approximately 100 microns.

Clean room cleanliness classifications are described in Tables 1 and 2, which show the relationship between Class designation and extent of particles per ft³. For example, a Class 10,000 / ISO 7 clean room will limit the concentration of particles of ≥0.5 µm to 353,000 particles /m³ (10,000 particles/ft³ of air). To compare to the typical workplace, 35,000,000 particles/m³ (0.5 - 1,000,000 particles/ ft³) 0.5 µm and larger are constantly present in the atmosphere (per ft³) of a typical office building.

US FED STD 209E Class	Table 1 - US FED STD 209E Cleanroom Classification ¹ - Maximum particles/ft ³					ISO Equivalent Class
	≥0.1 µm	≥0.2 µm	≥0.3 µm	≥0.5 µm	≥5 µm	
1	35	7.5	3	1	0.007	ISO 3
10	350	75	30	10	0.07	ISO 4
100	3,500	750	300	100	0.7	ISO 5
1,000	35,000	7,500	3,000	1,000	7	ISO 6
10,000	350,000	75,000	30,000	10,000	70	ISO 7
100,000	3.5 x 10 ⁶	750,000	300,000	100,000	700	ISO 8

1. Clean room classifications in Table 1 above was the US federal standard (US FED STD) 209E, until it was cancelled by the US Department of Commerce on 29th November, 2001 and superseded by the ISO standard 14644-1. The US FED STD 209E classification for clean room is still widely referenced.

ISO 14644-1 Class	Table 2. ISO 14644-1 Clean Room Classification Maximum particles / m ³						US FED STD 209E Equivalent Class
	≥0.1 µm	≥0.2 µm	≥0.3 µm	≥0.5 µm	≥ 1 µm	≥5 µm	
ISO 1	10	2.37	1.02	0.35	0.083	0.007	
ISO 2	100	23.7	10.2	3.5	0.83	0.07	
ISO 3	1,000	237	102	35	8.3		1
ISO 4	10,000	2,370	1,020	350	83		10
ISO 5	100,000	23,700	10,200	3,500	832		100
ISO 6	1 x 10 ⁶	237,000	102,000	35,000	8,320	0.7	1,000
ISO 7	1 x 10 ⁷	237 x 10 ⁶	1.02 x 10 ⁶	350,000	83,200	7	10,000
ISO 8	1 x 10 ⁸	2.37 x 10 ⁷	1.02 x 10 ⁷	3.5 x 10 ⁶	832,000	70	100,000
ISO 9	1 x 10 ⁹	2.37 x 10 ⁸	1.02 x 10 ⁸	3.5 x 10 ⁷	8.32 x 10 ⁶	700	

A wide variety of industries use clean rooms that range from large semiconductor facilities to hospital therapy and operating rooms. Some key applications are as follows:

- **Microelectronic clean rooms:** changes in temperature, humidity, particulate, static, and pressure levels are known to critically affect each stage of the production of semiconductor manufactures. Since many steps are involved in order to come to a final product, undiscovered defects can be expensive, if left until the end of the manufacturing process. Therefore, it is crucial that each and every clean room

(usually fabrication area or FAB area), operates properly, within its own level of cleanliness. Semiconductor FAB facilities can be large, complex facilities with numerous air flow paths, plenums, and under floor areas: aspirating smoke detection is well-suited to provide reliable, capable smoke detection. Figure 1 on the following page illustrates the complexity and features that can be found in semiconductor facilities.

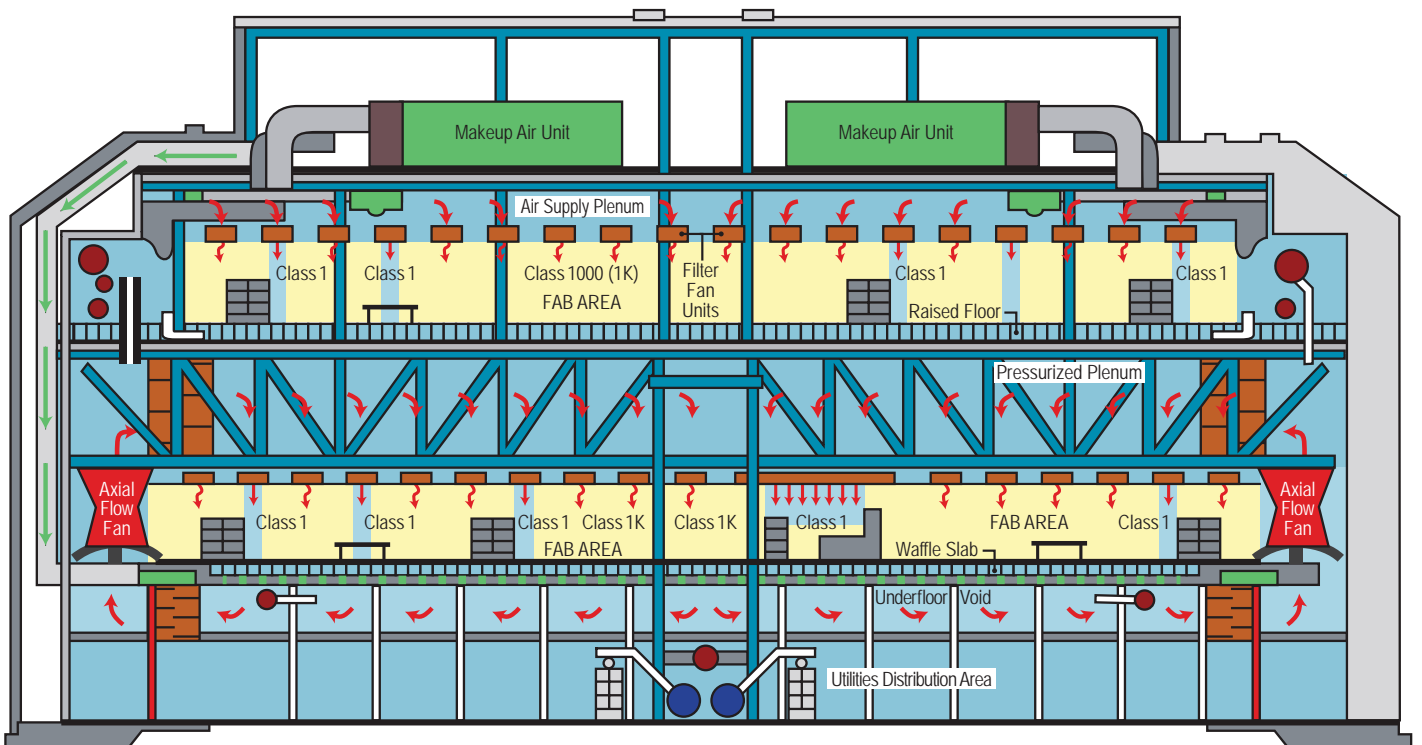

A ea a la ge emi n a ili an e man ai l pa a e i

Figure 1. – Semiconductor Facility

- **Biotechnology and Pharmaceutical Clean Rooms:** contamination is a major concern in this type of clean room, so it's crucial to maintain a cleanable surface condition via different sanitisation methods. Clean room seal has to be maintained while sanitisation or filter changes occur. This type of clean room primarily considers pressurisation control, absence of cross-contamination, and filtration of outdoor air, as well as indoor air. Staff working in this type of clean room (or in the previous one), is required to wear appropriate full gowns, hair nets, booties, and gloves, as they are a major source of contamination.
- **Medical Device Clean Rooms:** the main goal associated with this clean room type is the elimination of final product surface contamination so that the packaged medical device can be safely utilised by the end-user. Although cleanliness levels are maintained for the staff and the room itself, this type of room is typically designed for the 10,000 Class and the 100,000 Class. Personnel are allowed to work wearing smocks, hair nets, booties, and gloves.
- **Defence Industry Clean Rooms:** the application scope of this type of clean room can include the three aforementioned types. Nevertheless, due to their strategic sensitivity, defence industry clean rooms are provided with high levels of security.
- **Research and Development (R&D) Clean Rooms:** incorporated in private companies and universities, R&D clean room designs need to adapt for flexibility of future goals, objectives, and natures of corresponding operations. In other terms, designs of the clean room building layout and associated air-handling systems are planned to undergo minor modifications in order to accommodate different levels of cleanliness required for anticipated goals and objectives.



Figure 2. Large biotech clean room



Figure 3. Modular clean room



Figure 4. Semiconductor cleanroom

It should be noted that some industries – such as the ones involving plastic moulding injections for food and drug enclosures and plastic extrusions for medical devices – have moved towards clean environments with features called “white rooms.” Nevertheless, the design and the specifications of “white rooms” are lower than the ones defined for clean rooms.

As illustrated by the diversity of clean room applications, the corresponding volumes of clean rooms can range from a laboratory size to an industrial manufacturing plant. Depending on the industry/application, the airflow designs and filter types can vary. The required level of cleanliness is managed through an air-handling system, which entrains undesirable airborne particles and either collects them on HEPA or ULPA filters or sends them to scrubbers and combustors. HEPA (High Efficiency Particulate Air) filters are designed to remove 99.97% of passing airborne particles measuring 0.3 µm or greater in diameter. ULPA (Ultra-Low Penetration Air) Filters are rated as 99.999% efficient with particles 0.12 µm in diameter. Table 3 below lists some example clean room applications and corresponding cleanliness classifications.

US FED STD 209E Class	Table 3 - Clean Room Class Definition and Examples of Clean Room in the Class
1	Sub-micron integrated circuit manufacturing
10	Semiconductor manufacturing with circuits with line width below 0.2 µm
100	Particle-free manufacturing of aseptically produced injectable medicines. Steriliser unloading, sterile storage area, filling rooms. Implant or transplant surgical operations. Isolation of immunosuppressed patients
1,000	Manufacturing of high quality optical equipment. Rooms containing Class 100 areas or Laminar Air Flow hoods (LAF hoods) for filling. Assembly and testing of precision gyroscopes. Assembly of miniaturised bearings
10,000	Assembly of precision hydraulics or pneumatic equipment, servo-control valves, precision timing devices, high grade gearing. Pre-culture, fermentation, buffer and media preparation rooms
100,000	General optical work, assembly of electronic components, hydraulic and pneumatic assembly. Prewash rooms, bulk storage areas, equipment assembly areas

Benefits of Aspirating Smoke Detection

Clean room equipment and manufactured products are susceptible to various forms of contamination, including smoke particles, flame and heat from fire. Such contaminants pose major risks, such as damage to expensive equipment, a shut-down of the manufacturing process, high decontamination costs, direct business interruption to the facility, and indirect business interruption to downstream users of the manufactured product. Aspirating smoke detection systems are highly sensitive, and they continuously sample low quantities of smoke that may be distributed and easily diluted by the constant airflow environments encountered in clean rooms.

Aspirating smoke detection systems can play a key role in the protection of clean room facilities. Some examples and viewpoints on the loss potential and impacts are noted below:

- FM Global (2012 Data Sheets 1-56) indicates that clean rooms present an intrinsic high value, while remaining important to other plant processes. Due to the necessity of maintaining a high level of cleanliness, fire combustion products and other contaminants generated by small incidents can cause major shut-down time and costly decontamination clean-up
- Mangarano (2004) reported that a class 100 clean room may approach a value of \$10,000 per m², including building equipment and stock inside, but not including monetary loss due to business interruption. Also, consider in semiconductor production that the silicon wafers used in chip fabrication can contain 300 chips on a 200 mm wafer. The value of one such wafer can exceed hundreds of thousands of dollars
- Sheffi (2007) describes one fire in detail – a 10 minute furnace fire, extinguished with sprinklers – as well as the aftermath of the fire that occurred in a Phillips plant in the US in 2000 Ericsson (one of Phillips’ two main clients), was forced to merge with Sony to stay in the cell phone market)
- The Hynix semiconductor fabrication plant fire that occurred 4th September, 2013, in Wuxi, China, forced its closure, making it the biggest registered loss for this type of industry: damage was estimated between \$900 million - \$1.1 billion USD [9,11]. Prices for DRAM chips increased significantly after the fire (by 27%), reflecting Hynix’s role as a significant producer of this type of memory (the Wuxi facility produced 10% of the world’s DRAM chips and almost 50% of the company’s own production)

Given the direct dollar loss and possible indirect losses of clean room fires, the need to identify even the smallest fire events (such as precursor smouldering or overheating equipment events), can be critically important. Electrical equipment such as high-voltage type apparatus can be prominent in clean room facilities and pose a constant ignition risk. Aspirating smoke detection systems provide high sensitivity by continuously sampling low quantities of air, including smoke that could be distributed and otherwise diluted by the filtered airflow environments encountered in clean rooms.

Clean room smoke-control systems are often required in order to prevent smoke and aerosol exposure, which can cause non-thermal damage. The objective of a clean room smoke-control system is to minimise the spread of contaminants within the clean room. This is accomplished with a dedicated smoke-control system or with the normal AHU or fume exhaust system, in conjunction with automation controls and dampers, to initiate a smoke control mode of operation. Aspirating smoke detection systems have the sensitivity and response capability to quickly detect smoke contamination in the air flow path. By using associated outputs of air aspiration detectors, important smoke control functions can be promptly initiated.

With aspirating smoke detection technology, a number of objectives can be achieved for the benefit of a clean room facility:

- Better response time for events
- Immediate shut-down initiation of recirculating air flows to minimize contaminating airflows

- Initiation of smoke control systems to mitigate contamination and damage.
- Better assurance of smoke detection, as compared to ceiling-mounted smoke detectors, whose performance can be negatively affected by clean room airflow patterns
- Low nuisance alarm rates, minimising unnecessary building evacuations that can result in downtime and loss of production

Design Best Practices

Identify and Understand the Airflow Management Scheme

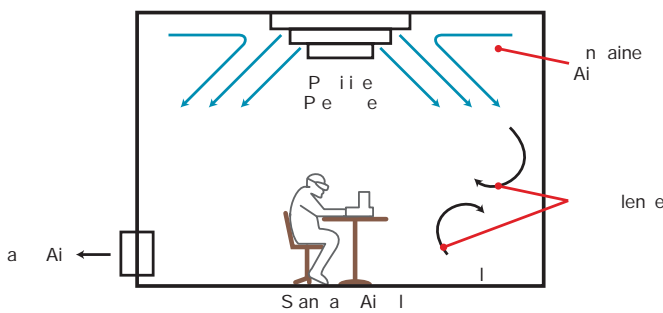

Figure 5. Standard airflow within a conventional clean room

There are numerous approaches to air distribution in clean room environments. Understanding the approach that is applied in any given facility will allow the designer to identify the key airflow paths that need to be monitored for smoke contamination. Maintaining clean air in clean rooms usually involves one or more of four basic approaches (Figures 5, 6, 7, and 8 on this page); however, other approaches and hybrid approaches are possible.

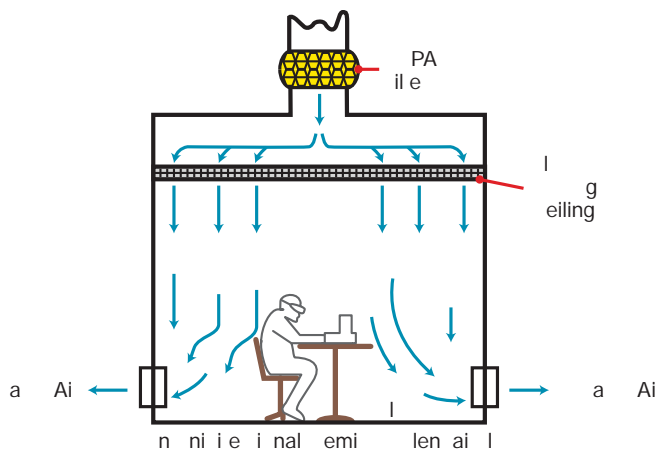

Figure 6. Semi-laminar airflow within a Class 10,000 clean room

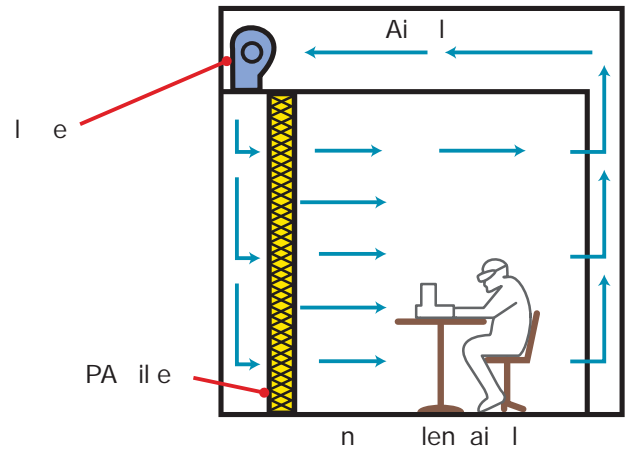

Figure 7. Horizontal laminar airflow within a Class 1, 10 or 100 clean room

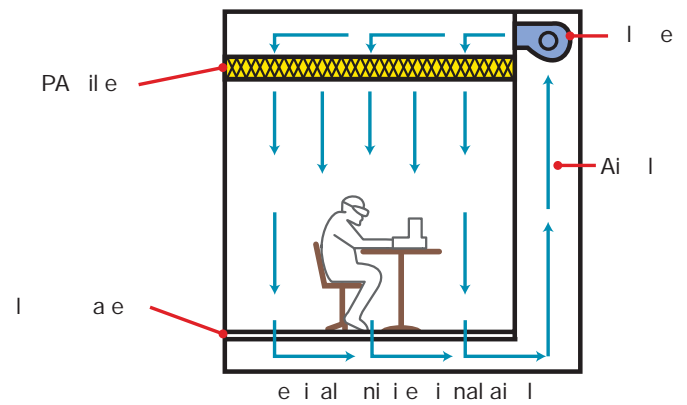

Figure 8. Vertical laminar airflow within a Class 1, 10 or 100 clean room

The conventional clean room (ISO Class 8, 209E Class 100,000): Incoming air to a conventional clean room comes in via ceiling filters/diffusers and exhausts through the wall-mounted registers as air returns to the HVAC system (see Figure 5 to the left). This flow of air creates a positive pressure between the clean room and its surroundings.

The semi-laminar flow clean room (ISO Class 7, 209E Class 10,000): This type of enclosed, clean area has air that is both conditioned and filtered, where the air comes in via a ceiling plenum. At that point, the air is diffused throughout the room, by way of many “slots” in the flow-thru ceiling tiles. Then the air is pushed vertically at low velocities and exhausts near or at the level of the floor (see Figure 6 bottom left).

The horizontal unidirectional flow clean room (ISO Class 3, 4, 5; 209E Class 1, 10 or 100): Incoming treated air enters through a HEPA filter wall, with a velocity of $0.51 \pm \text{m/s}$ ($100 \pm \text{ft./min.}$). An air return on the opposite wall is by where the clean room air is exhausted, entraining potential airborne particles produced in the work area.

The vertical unidirectional flow clean room (ISO Class 3, 4, 5; 209E Class 1, 10 or 100): This enclosed clean room design has the conditioned air enter by way of a HEPA filter ceiling. The filtered air moves straight downward at $100 \pm \text{ft./min.}$ ($0.51 \pm \text{m/s}$) as the design above, but the air is then exhausted via a grate system in the floor. This design is generally thought to be the one to use for “the optimum clean room.”

There are many possible design arrangements for clean rooms, varying by industry, room size, equipment accommodations, and building configuration. Given all these possible variations, the single most important consideration for aspirating smoke detection systems is the placement of air sampling points in the air handling systems and return air paths of any clean room air circulation scheme. Figures 9 and 10 (below and to the left), illustrate the basic concepts for aspirating smoke detection in the air flow path of clean rooms.

Smoke detection in the air circulation paths is important to protecting the clean air environment and mitigating contamination as follows:

- A fire event exterior to the building can introduce smoke contamination into the clean room environment from the outside air drawn into the main air handling units that supply the building and clean room environment. Aspirating smoke detection in the main air handling unit provides the means to quickly detect outside air contamination
- A fire event in the air handling unit (filter, motor) can introduce smoke contamination into the clean room environment directly from the main air handling units that supply the building and clean room environment. Aspirating smoke detection in the main air handling unit provides the means to quickly detect an air handling unit fire event

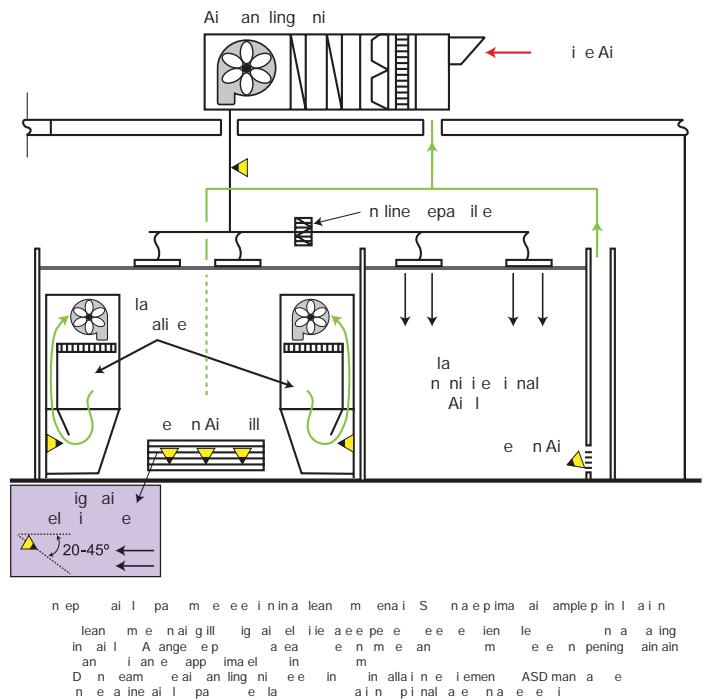

Figure 10. Basic concepts for aspirating smoke detection in the air flow path of cleanrooms.

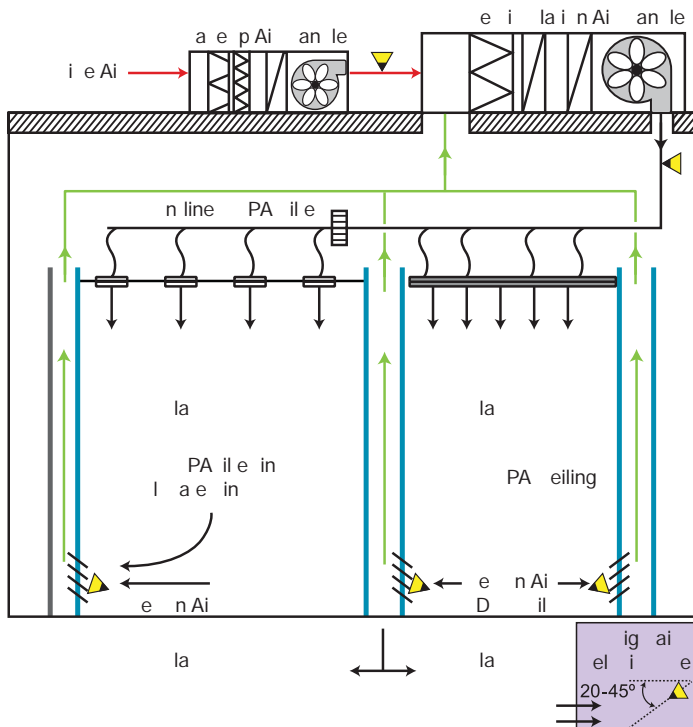

Figure 9. Basic concepts for aspirating smoke detection in the air flow path of clean rooms.

- The equipment, electrical systems, and combustible and flammable materials in a clean room arrangement may pose an ignition or fire threat in many potential locations. Due to the well-defined airflow schemes used in clean rooms, the provision of air sampling points at the return air grills, dry coil air returns, or return duct systems assures that smoke particulate will be readily detected by aspirating smoke detection systems
- Given the early or very early detection of smoke by aspirating smoke detection systems, appropriate signals can be sent through a fire alarm system interface to notify staff, to initiate smoke control and/or clean room pressurisation fans, and to shut down fans that are supplying/circulating contaminated air

In addition to the primary considerations for smoke detection in the air circulation paths, additional considerations support the need for comprehensive aspirating smoke detection in clean rooms. A risk or hazard assessment of the equipment, processes, and locations of potential ignition or fire hazards may result in a determination for more comprehensive placement of air sampling points. This may include any of the following areas in clean room environments:

- Clean room ceiling area
- Above-ceiling air supply plenums
- Under-floor spaces
- Critical mechanical spaces
- High value process equipment or work station areas

Depending on the location within the clean room facility (FAB or process area, under raised floors, ceiling ducts or plenums), air flow velocities can range from 1 m/s (fpm) - 100s m/s (fpm).

However, depending on the density of ceiling-mounted, filtered air supply and the class of clean room design, the number of air changes can be several hundred per hour. Generally, face velocity of ceiling-mounted filters is in the range of 0.25 m/s - 0.66 m/s (50 -130 ft./min). These near-ceiling velocities are in the range of typical smoke detectors, but due to the potential for high air changes, standard 84m² (900 ft²) spacing rules may not be suitable. A 37m² (400 ft²) coverage area or (6 m x 6 m) (20 ft. x 20 ft.) spacing should be considered when using aspirating sampling points in the main clean room process or FAB areas. Standard smoke detectors are generally not capable of performing in high air change environments. Because of room air currents' dilution and stratification phenomenon, sufficient smoke may not be able to reach a ceiling-mounted detector: if smoke can penetrate a ceiling-mounted detector, there may not be sufficient quantity of smoke to activate a standard smoke detector. There is a higher likelihood of detecting smoke particulates with multiple sampling points – using aspirating smoke detection – in the turbulent air flow regions or laminar flow regions of clean rooms.

NFPA 72 states that smoke detectors should not be used in air flow environments over 1.54 m/s (300 fpm), unless the detectors are specifically recognised for use in such applications. Both EN-54 and NFPA 72 recognise the challenges of detecting smoke in high airflow environments, and both stipulate reductions in detection point spacing in such high airflow conditions. When the air flow is approximately 60 air changes per hour, NFPA 72 requires spot smoke detectors to be limited to 11.6 m² (125 ft²) area of coverage. Aspirating smoke detection doesn't need to use such a limiting area of coverage, due to the additive effect when using multiple sampling points returning to an aspirating smoke detector, but air flow is an important consideration for aspirating smoke detection. Table 4 provides a general idea of the airflows and air change rates that may be encountered in various clean room designs.

ISO Class	FED 208 Class	HEPA Coverage as % of Ceiling	Air Velocity at Table Level in Clean Room m/s (fpm)	Air Changes Rate Per hour
1	-	100	0.36 - 0.66 (70-130)	>750
2	-	100	0.36 - 0.66 (70-130)	>750
3	1	100	0.36 - 0.66 (70-130)	>750
4	10	100	0.36 - 0.59 (70-110)	500-600
5	100	100	0.36 - 0.59 (70-110)	150-400
6	1000	33-40	0.13 - 0.20 (25-40)	60-100
7	10,000	10-15	10 - 15 (0.05 -0.08)	25-40
8	100,000	05-10	0.015 - 0.025 (3-5)	10-15

EN-54 can be helpful for determining the desired detection sensitivity for various types of clean rooms. EN-54 specifies a classification system for aspirating smoke detection according to Class A, B, and C categories as noted in Table 5 below. Depending on the Class of clean room and other attributes (monetary values, downtime risks, etc.), Class A, B, or C type aspirating smoke systems may be appropriate. Clean rooms with large air movement would favour EN-54 Class A systems, when aspirating smoke detection is being installed.

ISO Class	Sensitivity	Area of Application
Class A	Very high	Very Early Warning Fire Detection, building areas with high levels of air movement /air changes
Class B	Enhanced/High	Very Early Warning Fire Detection, building areas housing valuable goods and/or processes that need early detection
Class C	Normal/standard	Application for general fire protection, similar to standard point or spot detector applications

Semiconductor Fabrication: Clean room applications are vital to the semiconductor industry. NFPA 318, Standard for the Protection of Semiconductor Fabrication Facilities, stipulates requirements for smoke detection in semiconductor fabrication facilities and provides guidance when using aspirating smoke detection. NFPA 318:2012 requirements are as follows:

- Listed or approved smoke detection system be provided in the clean room return air-stream at a point before dilution from makeup air occurs
- Listed or approved smoke detectors to be located at the exit of both the makeup and the air-handling units
- An alarm transmission to a constantly supervised location in addition to a local alarm signal within the clean room, upon smoke detection activation within a clean room air system. The local alarm signal is to be perceived as different from any process equipment alarm signals in the clean room as well as from the whole facility evacuation alarm signal.

Although NFPA 318 does not mandate the use of aspirating smoke detection, it does recognise the inherent value of aspirating smoke detection in semiconductor fabrication facilities and contains recommendations for aspirating smoke detection placement. NFPA 318 recommendations for different semiconductor clean room configurations are presented in Table 6 on the following page. Figures 11 and 12 on the following page illustrate schematically where air sampling points may need to be located ,based on the requirements of NFPA 318.

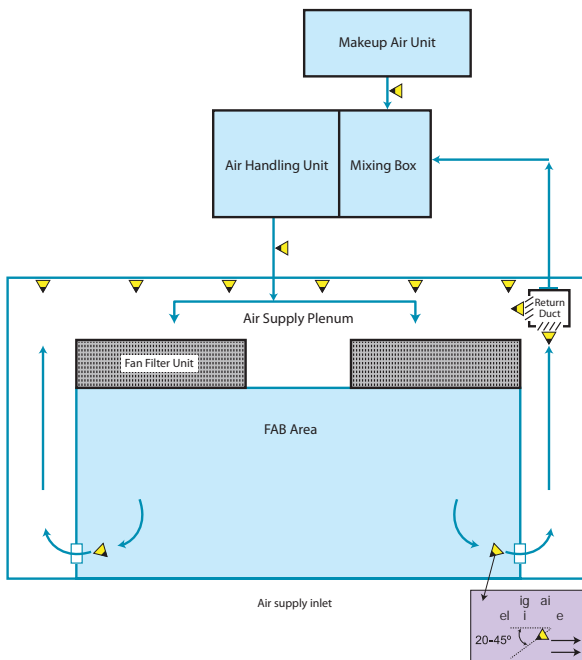

ne p a piaing m e e e in emi n a i a in a ilie S na e
 pi a l e i e m e e e in l a in m a e p a n a i a n l i n g n i a n a i
 p i n p i n g m e e e in n e l e a n m e n a i e a m a l a i n
 e e i l i n i m a e p a i n e m e e l l i n g l a i n a e
 e m m e e e PA Anne A e n g a p i a i n g m e e e i n
 e e e e n e a i e n
 n e a l p p l e n m a e e l e a n m
 e e e e n e e i l a i n g a i e m

Figure 11. Conceptual locations for air sampling points in semiconductor clean room scenario using fan filter units

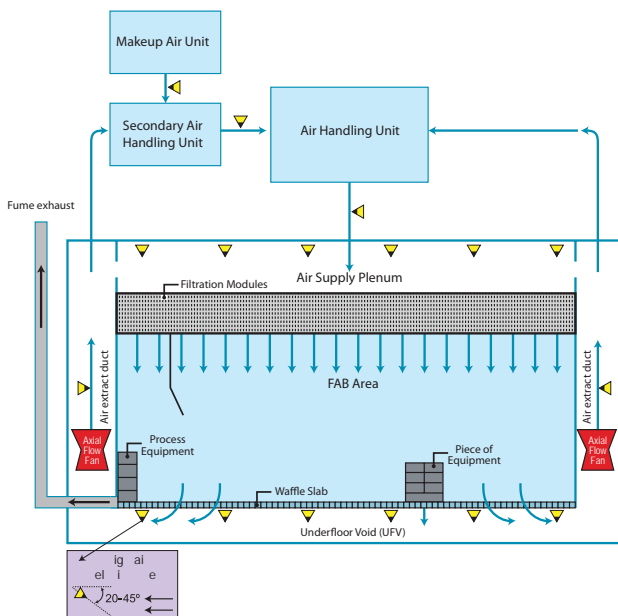

ne p a piaing m e e e in emi n a i a in a ilie S na e
 pi a l e i e m e e e in l a in m a e p a n a i a n l i n g n i a n a i
 p i n p i n g m e e e in n e l e a n m e n a i e a m a l a i n
 e e i l i n i m a e p a i n e m e e l l i n g l a i n a e
 e m m e e e PA Anne A e n g a p i a i n g m e e e i n
 n e a i e n a e e a i e n a n
 A e e i l l i n e a i p p l e n m
 e l a l e l a i n e n e l i

Figure 12. Conceptual locations for air sampling points in semiconductor clean room scenario using air supply plenum and waffle slab

Configuration	Recommended location (one or more of the following places)
Ballroom-style clean room with a pressurised supply plenum	(1) Below the waffle slab (2) Before the entry to the air return fans (3) In the air return ducts after the air return fans (4) In the air supply plenum above the clean room
Ballroom-style clean room with fan filter units	(1) Below the waffle slab (2) Before the entry to the air return ducts (3) In the air supply plenum above the clean room
Bay and chase clean room	(1) At ceiling level in the service chase return path (2) Before the entry to the recirculating air handling system

In the semiconductor clean room environment, there will be equipment referred to as "tools." A "tool" is any device, storage cabinet, workstation, or process machine located in the FAB clean room. Some tools are very costly; equipment can be worth millions of dollars. Often, this equipment poses a significant fire risk due to the use of plastic materials, flammable gases, and the presences of electrical power. Insurers may have specific requirements for fire protection for any given type of tool. Aspirating smoke detection can be vital in preserving sensitive equipment and tools. Air sampling points should be at key locations in the equipment, such as exhaust ducting connected to the tool. Upon detection, one or more of the following actions should be initiated:

- Alarm to a constantly attended location
- Activated interlock to shut-down power/high voltage
- Activated interlock to shut-down gas supplies
- Activated fixed fire suppression systems

Common Issues/Application Troubleshooting

The benefits of aspirating smoke detection – including the programmability of the remote sensor – make it a suitable detection system for clean room environments. However, there are several considerations for the use of aspirating smoke detection within clean room environments. During the design phase, the following factors should be considered:

- The designer needs to verify the airflow and direction of air within the space to maximise the system's effectiveness. The sampling points should be installed in the direction of the airflow
- For a large detection system with many sampling holes, the designer needs to account for smoke/air dilution. The more sampling holes the air sampling pipe contains, a greater volume of air is returning to the aspirating detector; this can dilute the quantity of smoke within the detection chamber and may delay the time it takes to initiate the alarm within the detection chamber
- The location of the sampling holes within the detection network is a concern. The further the sampling hole is located from the aspirating smoke detector, the more air/smoke dilution occurs, which could delay the time it takes to initiate the alarm within the detection chamber

- In normal applications, it is common for the air pressure in the protected room (PR) to be the same as the air pressure where the air is being exhausted from the detector (PE). The design software that is used to calculate transport times and detector sensitivities assumes equal air pressure in the two spaces. The sampling hole size, pipe size, transport time, and the fan aspirator speed are all functions of the air volume that passes through the sampling chamber. The sensing chamber is designed to detect smoke particles moving through the chamber at the speed of the fan. If PR is greater than PE, the velocities of the sampled air entering the chamber could be higher than the nominal fan speed, which could directly impact the detector's ability to sense smoke particles. Conversely, if PE is greater than PR, air pressure builds on the exhaust air, causing resistance and a drag on the fan. As a result, the fan may operate slower than designed, causing an increase in transport times and less air going into the sensing chamber. To eliminate the pressure difference, the exhaust air needs to be piped into the same room that is being sampled

During the commissioning process, the installing contractor needs to properly program the alarm thresholds and sensitivity levels because both could significantly impact the aspirating smoke detector's performance. The following programming considerations should be considered:

- Typically, aspirating smoke detectors are shipped with default settings from the factory. These generic settings are not appropriate for all detection systems because they may be either too sensitive or not sensitive enough for a specific application. It is necessary for the aspirating system designer to determine the alarm levels and program the sensor accordingly. The sensitivity levels and alarm thresholds are derived by a combination of the computer-based calculation program, the hazard being protected, detection system size and engineering judgment
- The programmable sensitivity levels are another significant issue impacting the performance of aspirating smoke detection systems. The detectors contain sophisticated electronics and software that allow the device to be programmed to a wide range of sensitivity levels. If these alarm levels are not programmed properly, then the quantity of smoke necessary within the sensing chamber may exceed the desired sensitivity and cause a delay in alarm signal initiation
- Time delays for trouble and alarm signal activation are also included at the detector. These delays can be set for a range of times, but typically span from 10 - 30 seconds. Consideration should be given when programming the time delays. The greater the delay, the longer it will take for the detector to initiate an alarm signal.

Dos

- Identify applicable codes and insurer requirements
- Identify and understand the classification of the clean room and associated air-handling features and airflow paths. Aspirating smoke detection systems have the sensitivity and fast response capability to detect smoke contamination threats in the air flow path at its earliest
- Identify and understand any smoke control and/or pressurisation schemes that need to be implemented upon smoke detection. Using associated outputs of air aspiration detectors, important smoke control functions can be promptly initiated
- Provide protection against smoke contaminating air flows by installing air sampling points for makeup air units, air handling units, and key air return points (air grills or dry coil returns to ducts or plenums). For air

returns, arrange the sampling ports so that each covers no more than 0.4 m² (4 ft.²) of the return opening

- Identify critical or high-risk equipment installations that should have localised areas or in-cabinet air sampling for earliest warning and initiation of human response
- Confirm the alert settings and fire alarm settings of aspirating systems and integrate them to initiate the following, if applicable: 1) power shut-down, 2) fixed fire suppression systems, 3) air handling shut-down and associated damper or door closures, 4) smoke control and room pressurisation operations, 4) gas supply shut-off
- When NFPA 318, Standard for the Protection of Semiconductor Fabrication Facilities, applies the following is recommended:
 - Install aspirating smoke detection in the clean room's return air-stream at a point before dilution from makeup air occurs. For implementation, evaluate and install aspirating smoke detection in one or more select areas of semiconductor facilities, as listed in Annex A of NFPA 318
 - Install aspirating smoke detection at the exit of both the makeup units and air-handling units

Upon smoke detection activation within a clean room air system, transmit alarms from aspirating smoke detection to a constantly supervised location in addition to a local alarm signal within the clean room. The local alarm signal is to be perceived as different from any process equipment alarm signals in the clean room, as well as from the whole facility evacuation alarm signal.

When EN 54-20 (Fire Detection and Fire Alarm Systems – Part 20: Aspirating Smoke Detectors), applies, the following is recommended:

- Review the clean room environment to identify the nature of the air flows and criticality of equipment or processes to be protected. This will help identify the sensitivity class of the aspirating system that needs to be installed in any given area
- Identify where Class C, aspirating type smoke detection is to be applied
- Identify where Class B, aspirating type smoke detection is to be applied. Class B systems are used when increased sensitivity is needed to compensate for moderate dilution effects due to high ceilings or moving airflows. Also, for protection of vulnerable and critical items.
- Identify where Class A, aspirating type smoke detection is to be applied. Class A systems are used in areas having very high air movement and high dilution; the very earliest warning is needed to protect highly critical business operations

Don'ts:

- Don't exceed the recommended detector or sampling point spacing of applicable standards or insurance carrier requirements
- Don't use detectors that are not listed or approved for air velocities and temperatures that will be encountered in the airflow paths of clean room facilities
- Don't design the aspirating system to exceed the transport time requirements of installation standards or insurance company requirements

Section 9

Large Volume Spaces

Application Overview

Large volume spaces include, but are not limited to:

- Spaces containing atria, such as hotel lobbies and shopping centres
- Warehouses and distribution centres
- Record/archive storage facilities and automated storage and retrieval warehouses
- Manufacturing plants, such as automobile assembly plants
- Convention centres, theatres, auditoriums, stadiums, and indoor sports facilities
- Cathedrals, churches, temples, and mosques
- Aircraft hangars and other large storage and maintenance areas
- Transportation terminals, such as airport terminals and train stations

Large volume spaces are spaces with ceiling or roof heights extending tens or even hundreds of m/ft. above the floor below. Some examples are hotels (see Figure 1 below), designed with an open atrium concept that extends through all floors of a tall building. More modest ceiling or roof heights may be found in public buildings such as shopping malls, sports venues, or convention centres. Ceiling heights of 9.1 m - 15.2 m (30 - 50 ft.), are quite common in the warehousing (see Figure 2 below), and manufacturing sector, with trends favouring heights far above 15.2 m (50 ft)



Figure 1. – An Atrium hotel provides a common example of a large volume space



Figure 2. - A warehouse provides a common example of a large volume space

and in excess of 30.4 m (100 ft.), such as in the case of highly automated facilities (e.g., Automated Storage and Retrieval systems [ASRS]).

In public buildings, tall spaces with glazed roofing designs allow for natural lighting and provide an appealing connection to the outdoors. However, the solar radiation that enters through large expanses of glass can often generate thermal gradients within the space, resulting in a hot gas layer near the ceiling/roof. This can vary from day-to-day, depending on thermal load and operations of the buildings' HVAC or natural ventilation systems. Smoke may not be buoyant or hot enough to penetrate the ceiling layer in such stratified hot layer environments, rendering spot smoke detection ineffective, if placed at or near the ceiling. Aspirating smoke detection systems, however, can be designed to avoid the issues posed for ceiling-mounted spot smoke detectors due to a solar induced hot layer.

Fire detection in tall and large volume spaces directly relates to the size of potential fires within the space. Typically, building contents such as furniture, large trash containers, or merchandise displays burn with enough energy to push smoke to significant heights. However, low energy fires with a small heat release rate can be difficult for ceiling or near-ceiling-mounted smoke detection devices to detect. Small, low-energy fires are subject to stratification solely due to gradual cooling of the rising smoke plume. As the smoke rises and entrains air, the temperature of the smoke and fire gases will decay until equilibrium is achieved with the surrounding air. At this equilibrium temperature, the smoke ceases to rise buoyantly and will diffuse into the surrounding atmosphere before reaching the level of ceiling-mounted detectors. Where detection of small fire sources is desirable – such as in heritage buildings or facilities where high-value contents are stored in a high-ceiling environment – the use of air sampling points at multiple locations and elevations can provide coverage that addresses both low energy fires and larger fires that exhibit the energy to force smoke to rise to the ceiling.

The impact of stratification can be seen in a real-world example of a historically important library reading room, as shown in Figure 3 below. In this case, the reading room is approximately (73 m long x 14 m wide x 15 m high (240 ft. x 45 ft. x 50 ft.)). Although the space is heated for winter months, air conditioning is not provided in the summer. The large glass windows around the reading room do allow for solar heat gain during hotter seasons, which can result in air temperatures that are greater in the upper portion of the space. Based on temperature measurements at various elevations, it was determined that temperature differences between floor and ceiling elevation could be in the range of 4.4° C to 9.4° C (8° F - 17° F).



Figure 3. – A historic library reading room with high ceiling condition (Photo: Courtesy of Dan O'Connor)

Ceiling Temp. 26° C (80° F), 90s Timeframe

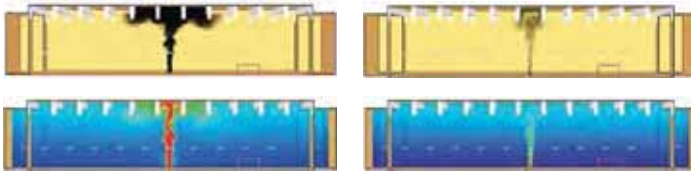

Figure 4 – Fire development in a near constant temperature environment

Using a CFD model, the development of a fire plume in the reading room can be visualised for the condition of a near constant temperature environment. At 90 seconds into the fire development, the 500 kW fire easily reaches the ceiling. A smaller 10 kW fire can reach the ceiling in this environment, but shows as a significantly diluted smoke condition, compared to the smoke obscuration created by the 500 kW fire.

Ceiling Temp. 42° C (108° F), 90s Timeframe

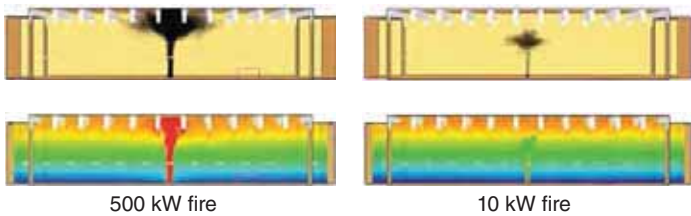

Figure 5 – Fire development in a layered temperature environment

A fire plume in the reading room can be visualised for the condition of a temperature gradient in the room. In this case the gradient is a temperature change of approximately 0.55° C (32.9° F) per meter. At 90 seconds into the fire development, the 500 kW fire easily reaches the ceiling. A smaller 10 kW fire, however, cannot reach the ceiling in this environment but shows as a developing stratified smoke layer.

As shown in the smoke stratification example for the historic reading room, a small fire could be a concern, even if it wasn't an initial threat. This justifies the need for very early detection, which can detect smoke before other combustibles contribute to a larger fire that would pose a threat to the historic fabric and contents in the room. The absence of automatic fire suppression may heighten concerns of a developing fire; aspirating smoke technology offers the early detection capabilities and installation efficiency for smoke detection in which stratification and detection of low energy fires is a necessary objective in a large volume space.

Benefits of Aspirating Smoke Detection

Aspirating smoke detection technology can benefit large volume spaces that may also have very tall ceiling or roof heights. Objectives include:

- **Better assurance of smoke detection:** The performance of ceiling-mounted smoke detectors can be negatively affected by dilution and stratification effects in a large volume space
- **Active air sampling:** Aspirating technology allows for active air sampling in large open spaces, multiple elevations, and return air paths, which offsets smoke stratification and dilution effects. Aspirating technology can be most beneficial in spaces where smoke generated from small fires would not have enough buoyancy to reach the ceiling

- **Different levels of warnings and alarms:** Specific alerts provide an opportunity for building staff to investigate, before emergency operations (such as evacuation), are implemented

- **Prompt initiation of smoke control and smoke exhaust systems:** aspirating technology assures the initiation of systems that mitigate smoke hazards, contamination, and damage. Many large volume spaces utilise smoke management features, to limit the development of smoke conditions in the large space and/or control the spread of smoke to other spaces

In addition to benefits accrued from effective and early detection in large spaces, aspirating smoke detection systems can provide flexibility and cost-savings not leveraged using other smoke detection technologies:

- **No special equipment required for inspection and testing:** an air sampling pipe network can be in the upper elevations of large volume spaces while the air sampling detector is installed in a remote accessible location, assuring easy maintenance. By comparison, spot or point-type detectors located on high ceilings would require special procedures for inspection

- **Diverse placement options:** aspirating technology allows for a variety of horizontal and vertical sampling point locations and/or capillary tubes, which provide effective smoke detection coverage while minimising architectural and aesthetic impact

- **Constant, reliable smoke detection:** aspirating technology performance is not subject to building movement considerations that have presented issues for optical beam smoke detection devices

Design Best Practices

There are two basic categories of large volume spaces to address:

Category 1: Large volume spaces with fire load contents, generally of limited height 2-3 m (6.5 ft. - 9.8 ft.), located on the main floor or other floors open to the large volume. These spaces tend to have moderate to large occupant loads. Examples are atrium buildings, single-story manufacturing areas, heritage buildings, religious worship buildings, and airport terminals.

Category 2: Large volume spaces with tall stacks or piles of flammable contents, which may or may not be in storage racks. These contents occupy a significant portion of the volume and height of the space that is most often one story. These spaces tend to have low to moderate occupant loads and a high value of contents. Examples are warehouses, distribution centres, automated storage and retrieval facilities, and library stack rooms.

There are many factors to consider when planning the design of an aspirating smoke detection system for a large volume space. NFPA 72 provisions on the spacing and location of smoke detectors states that, "The location and spacing of smoke detectors shall be based upon the anticipated smoke flows due to the plume and ceiling jet produced by the anticipated fire, as well as any pre-existing ambient airflows that could exist in the protected compartment."

To better understand the technical implications of this NFPA guidance, a number of basic scenarios are illustrated and described in Figures 6 – 11 on the following pages. The concepts are illustrated in a schematic fashion; proper execution requires a specific understanding of a given building's architectural features, ventilation features, fire characteristics, and smoke detection objectives. Large, growing fires that threaten life and property are important in most scenarios and often result in the activation of smoke management systems and/or evacuation alerts.

However, it's also important to detect small fires that may not be an immediate threat, to alert staff and allow time for preventive or investigative actions.

The appropriate design and implementation of smoke detection for large volume spaces is often developed from a performance-based design concept, which identifies high-level objectives, project-specific goals, and performance criteria for fire and safety systems. For details and background regarding considerations and approaches to performance-based design, the following three documents are recognised useful references:

- Society of Fire Protection Engineers, Engineering Guide to Performance-Based Fire Protection Analysis and Design of Buildings
- British Standards Institution, BS 7974, Application of Fire Safety Engineering Principles to the Design of Buildings - Code of Practice.
- Australian Building Codes Board, International Fire Engineering Guidelines.

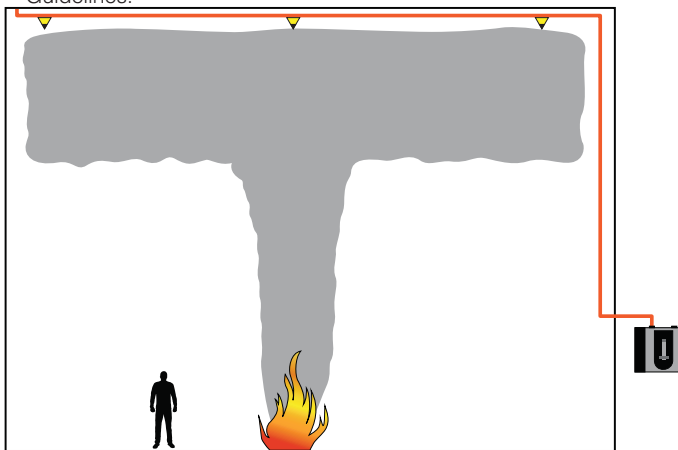

S enai ee e aa eeee neng ingie i
ell eel pe iepl me la inga pia ing ampling p in ne ig
ellingi app pia e i ae ee inglage g ingie nlage
l me pa e e elling ampling p in an p iee einl nge e
e m e aa ill e en e pie aea

Figure 6.

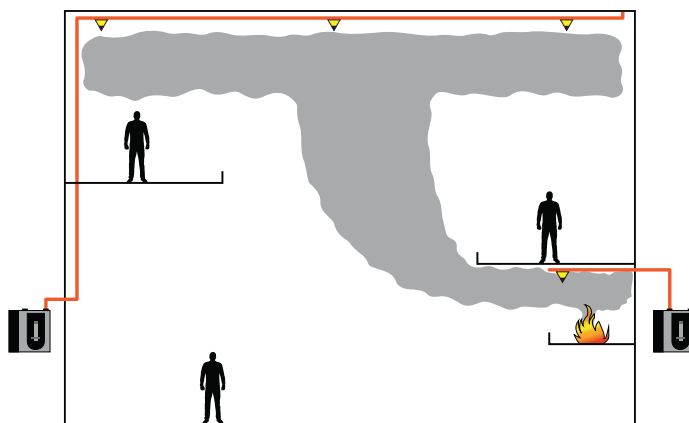

S enai ee e aa eeee neng ingie i
ell eel pe iepl me a pill in pie leel in e lge
ele ain e pa e enl a inga pia ing ampling p in ne
ig elling an a el leel ma eapp pia e ampling l ain n
i i ain ee enia nen eal ee in an ene
a eel ping m e aa n e ppe pie pa e an iniain
m e n le a ea e

Figure 7.

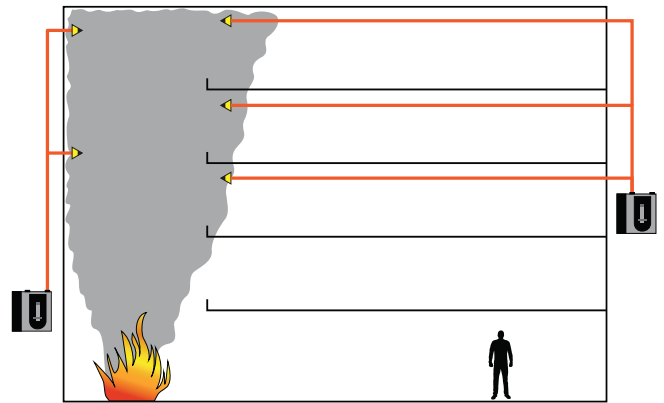

S enai ee e aa eeee neng ingie i
ell eel pe iepl me a pill in a all na pa e n i aea ie
pl me an ee pe e na eie all i en e
i an ea ena pa ee al app ima el e eig
e iing iepl me e ample a iepl me enee in e pa e a
ie ill na eie all a pa e ai ee ien i
i ain ai ampling p in lae n l n eie all pe imee l
aea e all na pa e an e ien ap ean ee m e
illing e pa e

Figure 8.

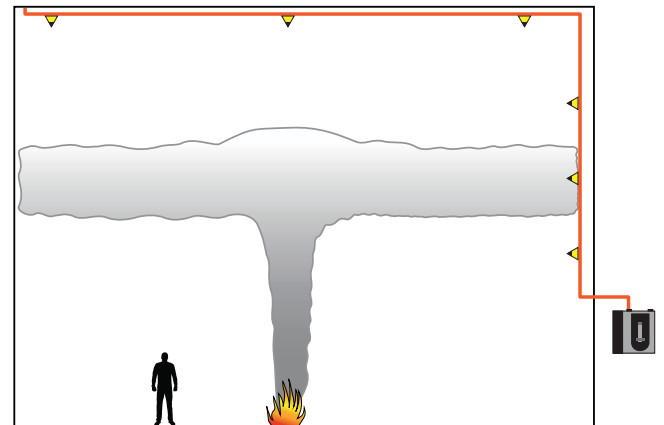

S enai ee e eiei ee ie en e ae elai el mall
i limie me an ee empa e ange in e pa ma
a e aiain e e ampling p in a m lple ele ain an ean
eeiea pia ing ee in l in nman ae elling ee in
ampling p in l al ep ie a ee in lage an
iepl me a illp m e ea il e elling

Figure 9.

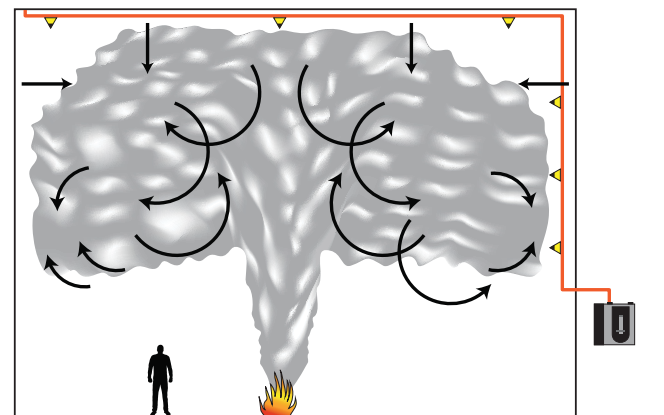

S enai n mela ge pa e a mall m eae iema a e e
an ea e elling le el e eai en imnen an
a iae ling e iing m e m e n in ma e
ign i an l i ean il e ing m lple ai ampling p in m e an
e lle e a m lple l ain an ana e a pia ing ee in
ni e m laie e e m e e ing ample m m lple p in
an e m e il nee an p i e ee iee in a l
n ea iee i p m e ee

Figure 10

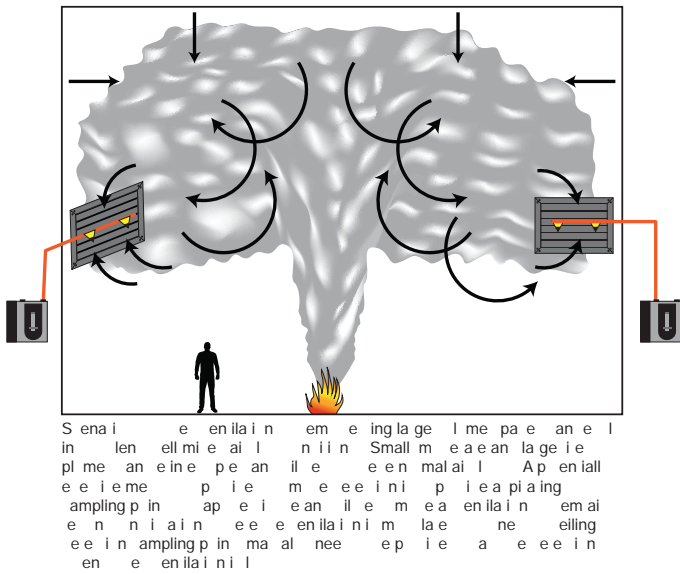

Figure 11.

In Figure 9 on the previous page, stratification was noted as one scenario that should be accounted for when detecting smaller fires, or when significant temperature gradients may prevent smoke from rising to ceiling detectors. NFPA 72 specifically notes that the effect of stratification should be accounted for in smoke detection system design. This requires a determination of whether or not the anticipated fires of interest (fire heat release rate), could be subject to stratification in the temperature environment of a large volume space. NFPA 72 provides guidance and methods to make this determination in its Annex B-Engineering Guide for Automatic Fire Detector Spacing.

The graphical method, shown in Figure 12 below, is also applicable in tall spaces with a uniform temperature gradient. In Figure 12, the arrow at the y-axis points to a temperature change (ΔT) of approximately 39° C (70° F). Following this line across – to the intersection of the 106 kW heat release rate fire curve (a large trash can fire) – allows for a cross reference to the x-axis, which indicates the maximum height that smoke can rise to. In this case, if the ambient temperature at the floor of a smoke detected space is 20° C (68° F), then a temperature of 59° C (138.2° F) ((20° + 39° C/ 68° F + 70.2° F), would result in stratification of smoke from a 106 kW fire at 9.5 m (31 ft.) above the floor. This is a fairly large temperature difference over a 9.5 m elevation change and perhaps an unlikely temperature condition in occupied buildings. However, assuming such a temperature

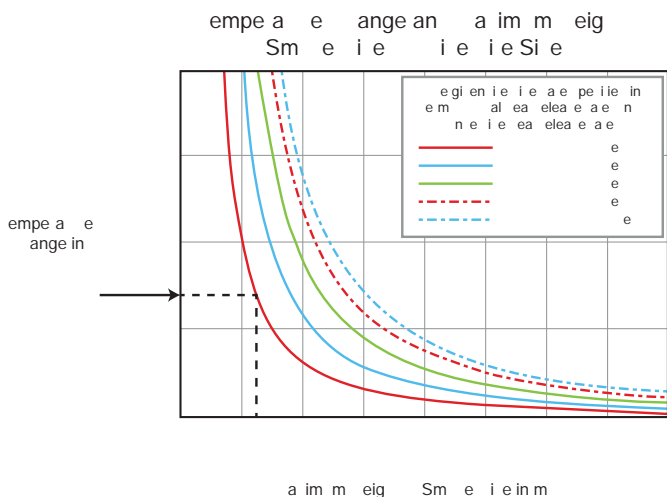

Figure 12. – Smoke Rise in Spaces with a Uniform Temperature Gradient

change is likely, this example shows that 106 kW fires or larger will reach ceiling detectors at a ceiling height up to 9.5 m.

The methods in NFPA 72-Annex B provide a technical basis to address the potential for stratification. Stratification, however, may not be the relevant concern for detecting smoke in large volume, high ceiling spaces. In the European fire detection community, much attention and full scale research (Building Research Establishment, “Smoke Detection in High Ceiling Spaces – Report 3”, BRE Global, 19th November, 2010), has been given to the assessment of adequate smoke detection in high ceiling spaces (43 m or 143 ft.), for small to moderate fires (5.8 kW to 560 kW). More specifically, the fires considered were as follows:

Smoke Source	Approximate Heat Release Rate - kW	Smoke Characteristic
Small wooden crib	220	Very limited grey
n-heptane	400	Limited black
Large wooden crib	560	Limited grey
53 sheets of paper, loosely packed into bin	30	Grey
potassium chlorate and lactose	45	White
Smoke pellets on top of gas burner	5.8	White

Prior to conducting this research, European codes did not recognise the capabilities of aspirating detection technology for ceiling heights beyond a range of 10.5 m - 21 m (10.75 ft - 68.8 ft.); the latter value is only applicable to property protection scenarios. The research provided insight into the capability and values of aspirating detection technology for smaller fires as opposed to fires with rapid growth and high heat release rates. Three noteworthy conclusions provided the basis for revisions to the FIA code of Practice (CoP) for ASD systems based upon using the EN54-20 Classes of Sensitivity; Class A, B, and C. Key research conclusions from this study are as follows:

- ASD detectors can detect smoke that rises to the ceiling from relatively small fires, despite vertical temperature differences
- Multiple air sampling ports carry a significant advantage over cumulative or additive effects and provide better detection, as opposed to a single sampling port. Testing showed that 1-pipe/4-hole ASD system responses were better than a 1-pipe/1-hole ASD system, and the 4-pipe/20-hole ASD system responses were better than the 1-pipe/4-hole ASD system
- In the absence of cross-flows, but in the presence of a 12° C (22° F) temperature difference, between the floor and ceiling, smoke rose to the ceiling with no evidence of any thermal barriers to cause stratification

European testing has brought about revisions to the FIA code of Practice (CoP) for ASD systems, based upon using the EN54-20 Classes of Sensitivity. The EN54-20 three classes of sensitivity are a measure of the individual sampling holes' sensitivity and not the ASD detector system. Table 2 provides a brief description of the three EN54-20 sensitivity classes.

Table 2 EN 54-20 Sensitivity Classes vs. Typical Detection Scenarios		
Class A Very High Sensitivity	Class B Enhanced Sensitivity	Class C Normal Sensitivity
Smoke is not visible due to low quantity of smoke and/or high dilution caused by air movement	Smoke is visible, but insufficient to be detected by point* or beam technologies*	Smoke visible and sufficient to be detected by point* or beam technologies*
* According to EN-54 Part 7 or 12		

Based on the BRE research efforts, the FIA Code of Practice (CoP) for ASD has been revised to include the following recommendations for aspirating detection systems in high ceiling applications. The FIA CoP notes that the recommendations in Table 3 may be used as a basis for variations from national codes on a project by project basis.

Table 3 – FIA CoP - Recommended Ceiling Height Limits for ASD				
Assumes that there is no stratification and that smoke rises to the ceiling unimpeded by thermal gradients				
Detector type	Generally applicable Maximum ceiling height		10% of ceiling height no Greater than	
	General Limits	Property Protection Scenarios 1	General Limits	Property Protection Scenarios 1
Any ASD system approved to EN 54-20	10.5 m	15 m	12.5 m	18 m
ASD system with: at least 5 Class C holes or at least 2 Class B holes	15 m	21 m	18 m	26 m
ASD system with: at least 15 Class C holes or at least 5 Class B holes	25 m	40 m	28 m	43 m
ASD system with: at least 15 Class B holes	40 m	40 m	43 m	43 m
Note 1. Assumes 5 minute fire service/fire department attendance or response.				

The following recommendations are also applicable to Table 3 bottom left.

- The ASD holes should be located close to the ceiling (typically within 600 mm/1.9 ft.), and spaced in accordance with maximum areas specified in national codes
- An enhanced response can be achieved by using an ASD with increased Class, e.g., a Class A detector with at least five holes will provide enhanced detection in spaces up to 25 m (82 ft.)
- An enhanced response can also be achieved by using a higher density of sampling holes. For example a Class B system with 10 holes at half the spacing (e.g., 5 m (16.3 ft.), as opposed to 10 m (32.75 ft.), will provide enhanced detection in spaces up to 25 m (82 ft.)
- Where possible spacing of sampling holes should be in two dimensions (covering an area as opposed to a single line of sampling holes)
- If multi-port ASD systems, which identify the source pipe are used, the minimum number of holes (15 or 5), should be on each identifiable section/pipe
- If stratification occurs, detection may be delayed until the heat produced by the fire is sufficient to penetrate the stratification layer. Where there is significant stratification or a requirement to detect smaller fires the provision of vertical sampling should be considered
- Any air flows (e.g. as a result of air conditioning), should be considered and taken into account by the provision of primary sampling where necessary

Warehouse Facilities

Warehouses, distribution centres, automated storage and retrieval facilities, and library stack rooms are a unique category of large volume spaces that require additional considerations beyond those previously discussed. Stacks, racks, and material handling equipment allow these facilities to efficiently store large quantities of inventory or important documents and items archived for legal or historic purposes. A large fire can be catastrophic, potentially costing millions of dollars in lost contents or major business interruptions. Warehouses serving the food industry are very susceptible to loss from sprinkler-controlled fires due to smoke contamination and water damage. Modern warehouses and storage facilities often rely on automatic sprinkler systems for basic fire protection; however, the potential loss and importance of key supply chain facilities, extreme high value storage, and irreplaceable archived storage can warrant the installation of early warning smoke detection for staff intervention before sprinklers are needed. Arson and electrical/mechanical systems account for a significant percentage of warehouse fires, and aspirating smoke detection can provide early indications of such events and allow for manual fire suppression or de-powering of equipment.

The following internal warehouse conditions should be assessed as part of the air sampling system design process:

- Temperature and humidity profiles – variations on temperature throughout the day and across the seasons may pose stratification concerns that should be addressed
- Airborne particulate levels – consider the type of operation and how particulate levels relate to ceiling height in order to prevent nuisance alarms from non-fire related particulates
- Ventilation – how the area is ventilated (e.g. mechanical, air conditioning, exhaust fans, natural ventilation, building leakages, rolling doors opening/closing) may determine airflow patterns prior to the fire conditions
- The presence of high storage racks

Large, open warehouse spaces contain great volumes of air; fire smoke, produced in the early stage of the fire, can be easily diluted and therefore difficult to detect. Fresh air coming from open vents (e.g., open aircraft hangar doors), can also dilute the smoke inside the structure.

By definition [NFPA 72], stratification is the “phenomenon where the upward movement of smoke and gases ceases due to the loss of buoyancy.” This phenomenon can occur in the high ceiling environments of warehouses, where the thermal buoyancy of the smoke is insufficient to reach the detection points on the ceiling, which results in horizontal layers of air and smoke in varied temperatures. Stratification layers will also be influenced by ventilation and external environmental conditions. For example, the summer sun can cause temperatures in excess of 60° C to 70° C (140° F to 158° F), if it strikes just below a steel warehouse roof. If a small incipient fire starts at the ground level, its smoke would not have enough energy to breach this higher temperature air barrier and the majority of smoke particulates would not reach the ceiling detection points. Instead, a smoke layer would form beneath the upper hot air layer. To increase sampling point effectiveness, it may be necessary to conduct sampling at different heights to detect the smoke particulates.

Plastic pipes are used in most normal warehouse applications, but extreme temperature variations would be better suited for a damage-resistant alternative, like copper pipe. Consider this possibility during sampling pipe network design. The thermal characteristics of commonly used plastic pipe materials are presented in Table 4 below.

Table 4 – Thermal Characteristics of Plastic Pipe Commonly Used

Pipe material	Temperature range	Pipe variation within the temperature range
ABS	-40° C to 80° C (-40° F to 176° F)	10.1 mm per 10 m per 10° C (0.4 in. per 32.8 ft. per 18° F)
CPVC	-18° C to 94° C (0° F to 201° F)	6.7 mm per 10 m per 10° C 0.26 in. per 32.8 ft. per 18° F)

There are four complementary design options for the configuration and location of ASD sampling pipes and holes in warehouse and storage buildings. Selecting a sampling pipe configuration is dependent upon the warehouse application and internal characteristics (e.g. presence of high-bay racking, mezzanines, and voids), as well as the facility’s operational objectives and smoke detection objectives (performance-related). All sampling pipe network configurations should be verified using appropriate supporting design software.

1. **Near Ceiling Detection**– sampling pipes are located close to the ceiling only
2. **Below Ceiling Detection** – sampling pipes above a ceiling use drop down pipes or capillary tubes with sampling holes
3. **High-Low Alternating Detection** – sampling pipes are located on the ceiling with alternating sampling holes on the ceiling and drop-down pipes
4. **Multi-Level Detection** – this detection method applies to warehouses comprising high bay storage racks and utilises more than one ASD system for ceiling and intermediate level detection (Figure 6 on page 53)

5. **In-Rack Detection** – the sampling pipes run horizontally or vertically between back-to-back racks at various heights. Drop-down pipes from the ceiling can also be used for in-rack detection

In addition to these generic warehouse applications of ASD systems, additional protection should be considered in the following situations:

- **Office and control area** – for aesthetic reasons, sampling in these areas is usually conducted via capillary tubes fed through the ceiling from the main sampling pipes, which are located in the ceiling void (Figure 13 below).
- **Ceiling void** – it is especially important to protect ceiling voids containing cabling and/or any other equipment, due to an increased risk of fire. The spacing of the ASD sampling holes is again determined using the grid method (see Figure 13 below).

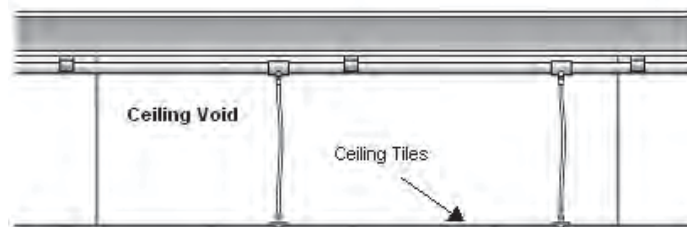

Figure 13. Example of capillary air sampling through the ceiling

- **ASD sampling pipes** – should not be placed underneath or in close proximity < 1 m (3.3 ft.), to lighting fixtures, heaters, skylights, or other heat-emitting objects
- **Loading bay** – ASD sensitivity should be lowered to account for the truck exhaust fumes, regularly present in the loading bay environment

For ceiling protection, sampling pipes can be installed directly onto the roof trusses when drilling into the roof decking is not allowed. If there are beams on the ceiling, the ASD pipe network can be fastened to the beams using suitable materials. If neither method is feasible, an alternative approach is to use catenary wire to support the pipe network.

Take local codes and standards into account when installing sampling pipes on sloped ceilings. For warehouses containing storage rack areas, sampling pipes can run perpendicular or parallel to the rack orientation. For intermediate level protection, sampling pipes should be installed on the underside of mezzanines (catwalks). Where mezzanines (catwalks) are not present, the pipes can be fitted to the sheltered side of the racking, fixed to the rack frame. It is important to ensure that the pipes are not in close proximity to stored goods or installed in locations where they could be damaged by forklifts. Wind loads and temperature fluctuations may cause expansion or contraction of the warehouse’s structural beams and pipes, so conduit saddles should be used to allow for small pipe length variations. Possible expansions or contractions also make it necessary to install airtight expansion joints to allow for pipe movement without jeopardising the integrity of the sampling pipe network.

For warehouses containing storage rack areas, it is recommended to place ceiling sampling holes above each aisle in a staggered layout (see Figure 14 on the following page).

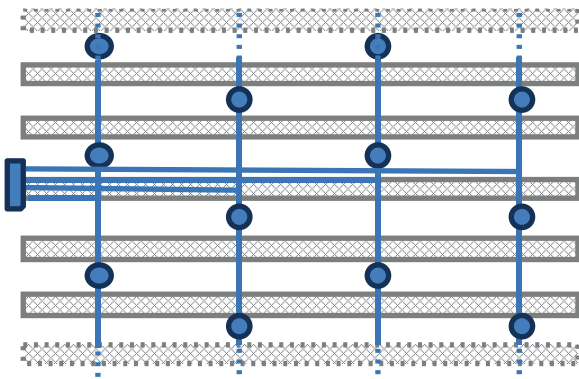

Figure 14 .- Staggered Layout

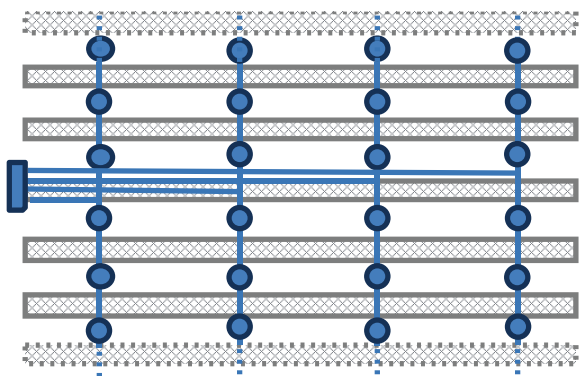

Figure 15 .- Standard Rectangular Layout

Each aisle is treated as a smoke compartment when the storage racks extend to the ceiling, therefore ceiling sampling holes should be located above each aisle in the standard rectangular grid layout (see Figure 15 above). In both of these layouts, the spacing between the pipes can extend up to the maximum distance permitted by local codes and standards.



Figure 16 .- Sampling pipe layout for storage rack area, where racks stop well below the ceiling (non-branched pipes parallel to rack orientation)

The spacing between sampling holes on the same pipe section will depend on the rack depth.

ASD units can be mounted wherever it is most convenient – on walls, columns or rack frames – but it's recommended to mount ASD units in close proximity. For example, these units can be located in the centre of a warehouse with the pipe network extending outward, toward the walls.

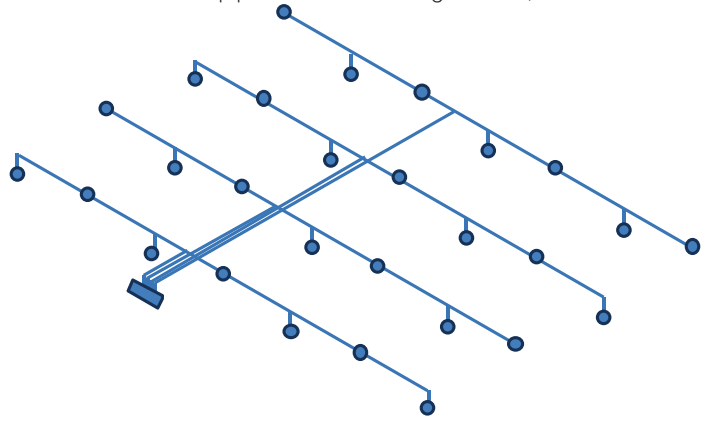
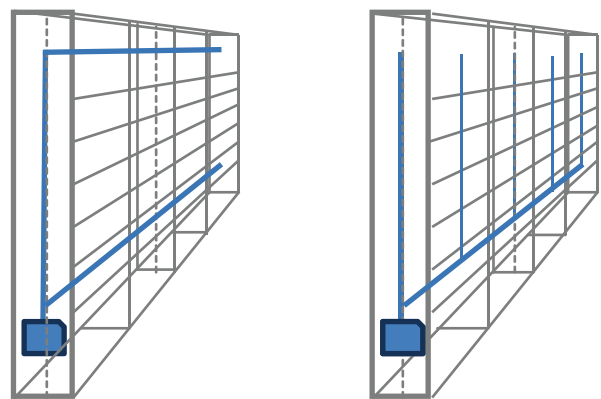

Figure 17 .- Example of High-Low Alternating Detection

This configuration minimises the distance between detectors and reduces wiring costs.

The high-low alternating detection option comprises of ceiling sampling holes that alternate with drop down pipes. This method is used to penetrate the hot air layer that may develop at the roof level, which allows for optimal sampling when the air at the roof level is either hot or cold. Consult local codes and standards to determine the correct length of drop down pipes for individual facility configurations. An example of a branched sampling pipe network is presented in Figure 17 above.



(a) Horizontal in-rack detection

(b) Vertical in-rack detection

Figure 18 .- In-rack detection

Warehouse In-Rack Detection

In-rack detection may be used in warehouse facilities where the following conditions apply:

- There is high-bay racking
- Stratification occurs
- Localised detection is required



Figure 19. Example of drop-down pipes for in-rack ASD

The sampling pipe can have either a horizontal or vertical in-rack detection configuration as shown in Figure 18 on the previous page. The detector is installed at the end of the rack at an accessible level. As a safeguard against mechanical damage from forklift trucks, sampling pipes are located between back-to-back racks out of harm's way.

In the case of non-high-bay racking, ceiling drop-down pipes may also be used for in-rack detection. When installing drop-down pipes, it is important to ensure that they will not be damaged by forklifts or be in close proximity to the stored goods. The drop-down pipes can be fitted to the sheltered side of the racking, fixed to the rack frame as shown (Figure 19 above).

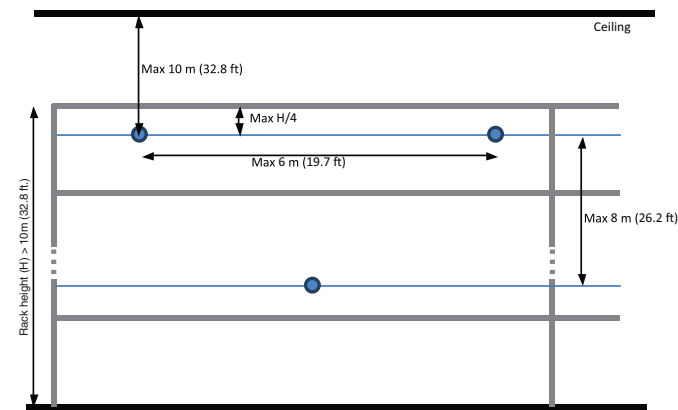

Figure 20. FIA recommendations for warehouse in-rack air sampling locations

In-rack drop-down pipes normally have two or three sampling holes drilled in them to provide sampling at different heights within the racking system. In the UK, the Fire Industry Association (FIA) recommends protecting warehouse high racking/shelving with air sampling points with a maximum horizontal spacing of 6 m (19.7 ft.), in order to reduce the possibility of smoke passing between sampling points.

In case of racks extending higher than 8 m (26.2 ft.), FIA recommends an air sampling top level within the top 25% of the rack height and no less than 10 m (32.8 ft.), from the ceiling.

For even higher racks, additional levels of air sampling are recommended with a maximum vertical spacing of 8 m (26.2 ft.), as presented in Figure 20 ,bottom left. It should be noted that each level should be offset to the one below if multiple levels of air sampling are installed, with the same objective: to reduce the possibility of smoke passing between layers of air sampling points.

A detailed positioning of in-rack pipework and air sampling points is dependent on the racking configuration and stored items. FIA describes the following options:

- Position the in-rack pipework and air sampling points within the space between back-to-back shelving
- Or position the air sampling points at the shelving edges, adjacent to the aisles

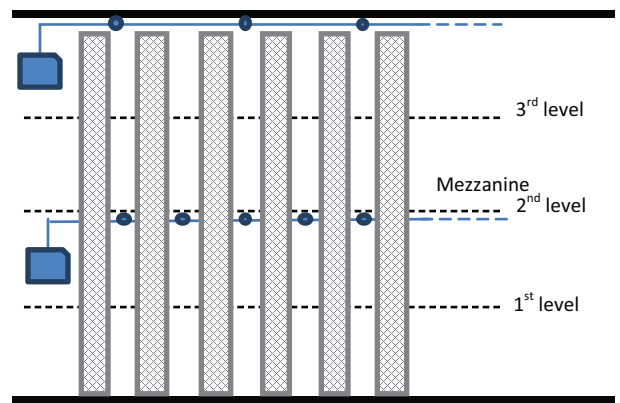

Figure 21. – Example of Multi-Level Detection (Ceiling and Intermediate Level)

Aisle-side sampling (air sampling points at the shelving edges), has benefits when compared to sampling at the centre of the rack, including easier installation and testing. Quicker detection is possible with aisle-side sampling as well, because the sampling points are closer to potential ignition sources. However, their side position makes them more prone to mechanical damage by vehicles or other equipment.

Warehouse Multi-Level Detection

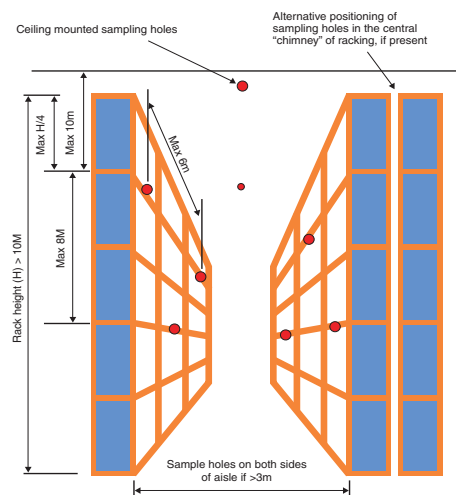

Figure 22. FIA recommendations for warehouse in-rack air sampling locations

The multi-level detection option is used in any of the following circumstances:

- There are high bay storage racking areas
- High stratification levels are expected
- Mezzanines (catwalks) consist of solid flooring that will impede/delay the ascend of the smoke plume

This design option requires one ceiling ASD system and multiple intermediate level ASD systems (Figure 21 on the previous page).

Important Note: ASD systems intended for intermediate level protection should have sampling holes in every aisle.

For aisle-side sampling, FIA indicates that providing it on both sides of an aisle should not be necessary for aisle widths under 3 m (9.8 ft.). When multiple levels of aisle-side sampling are provided, level offsets should be considered across the aisles, as shown in Figure 22 on the previous page.

Common Issues/Application Troubleshooting

Coordination and interfaces between an automatic fire suppression system and emergency protocols

It is important to coordinate the smoke detection system with the building management emergency plan. Since an ASD system handles multiple alarm thresholds over a wide sensitivity range, its interface with notification systems operation (e.g., horns, strobes), or could allow time for fire investigation, while the subsequent alarms could initiate evacuation and automated fire brigade notification.

Setting during design phase sampling locations and density, sensitivity levels and alarm thresholds appropriate for large volume space applications

Aspirating smoke detection has many benefits, and the remote sensor programmability makes it a suitable detection system for large volume spaces. However, there are several considerations for the use of aspirating smoke detection within large volume spaces. During the design phase, consider the following factors:

- The designer needs to verify the airflow and its direction within the space to maximise the system's effectiveness. The potential for stratification should be addressed
- For large volume spaces where smaller fires are the detection objective, smoke tends to become dilute and diffuse in the space. For better response, consider using more sampling holes and/or a higher density of sampling holes to enhance the cumulative effect
- Plan ASD unit locations carefully so end-of-system test points are accessible
- Background pollution or smoke (e.g., truck exhaust fumes), can be present in some large volume space environments. Consider and implement false alarm prevention methods as necessary, and mitigate the effects of background pollution or smoke. Such methods include day/night alternative sensitivity settings, or the use of reference detectors to offset measurements from active detectors and alarm delays to address short term transient conditions. For example, in the case of truck exhaust fumes from loading bay environments, sometimes it's effective to simply lower the ASD sensitivity.

Programming considerations of the aspirating smoke detector during the commissioning process

During the commissioning process, the installing contractor needs to properly program the alarm thresholds and sensitivity levels, because both could significantly impact the aspirating smoke detector's performance. The following programming considerations should be considered:

- Typically, aspirating smoke detectors are shipped with default settings from the factory. These generic settings are not appropriate for all detection systems because they may be either too sensitive or not sensitive enough for a specific application. It is necessary for the aspirating system designer to determine the alarm levels and program the sensor accordingly. The sensitivity levels and alarm thresholds are derived by a combination of the computer-based calculation program, the hazard being protected, detection system size and engineering judgment
- The programmable sensitivity levels are another significant issue impacting the performance of aspirating smoke detection systems. The detectors contain sophisticated electronics and software that allow the device to be programmed to a wide range of sensitivity levels. If these alarm levels are not programmed properly, then the quantity of smoke necessary within the sensing chamber may exceed the desired sensitivity and cause a delay in alarm signal initiation

Time delays for initiating further actions

Time delays for trouble and alarm signal activation are also included at the detector. These delays can be set for a range of times, but typically span from 10 - 30 seconds. Consideration should be given when programming the time delays. The greater the delay, the longer it will take for the detector to initiate an alarm signal.

Dos

- Identify applicable codes and insurer's requirements
- Verify all system designs, utilising the manufacturer's computer-based flow calculations
- For systems that protect high ceilings, plan ASD unit placement carefully, so that end-of-system test points are accessible
- Confirm how the alert and fire alarm settings of aspirating systems are integrated to initiate the following, if applicable: 1) power shut-down, 2) fixed fire suppression systems, 3) air handling shut-down and associated damper or door closures, 4) smoke control and room pressurisation operations, 5) evacuation alarms
- Refer to the appropriate sections of ASD application guides for air sampling techniques for air returns/In-duct applications (for ASD sampling of HVAC ducts)
- When NFPA 72, National fire Alarm and Signalling Code applies, the following is recommended:
 - Determine if the aspirating smoke detection system design is a prescriptive design or a performance-based design
 - For prescriptive designs, review and understand the performance objective (description of the purpose of the detector placement and the intended response of the fire alarm control unit to the detector activation

- For performance-based designs, review and understand the performance objectives for the fire alarm system design. This is usually part of a larger, comprehensive fire protection strategy for a facility or building area. The location and spacing of aspirating detection should be based upon the anticipated smoke flows due to the plume and ceiling jet produced by the anticipated fire, as well as any pre-existing ambient airflows that could exist in the protected compartment
- Refer to NFPA 72 Annex B for methods to evaluate the potential for stratification
- Account for the effect of stratification to the performance objectives, if relevant
- The following is recommended when EN 54-20 (Fire Detection and Fire Alarm Systems – Part 20: Aspirating Smoke Detectors applies):
 - Review the large volume space environment to identify the nature of the airflows, the potential for stratification, and the criticality of contents to be protected. This will help identify the sensitivity class of aspirating system that needs to be installed in any given area
 - Identify where Class C, aspirating type smoke detection is to be applied
 - Identify where Class B, aspirating type smoke detection is to be applied. Class B systems are used when increased sensitivity is needed to compensate for moderate dilution effects due to high ceilings or moving airflows. Also, for protection of vulnerable and critical items
 - Identify where Class A, aspirating type smoke detection is to be applied. Class A systems are used in areas having very high air movement and high dilution.

Don'ts

- Don't design the aspirating system to exceed the transport time requirements of installation standards or insurance company requirements
- Don't install ceiling sampling points too near to ceiling supply air diffusers. Maintain a distance of 0.9 m - 3 m (3 ft. -10 ft. from ceiling diffusers, depending on the strength of the airflow). See BS 6566 and NFPA 72 for specific requirements
- Don't locate ASD sampling pipes underneath or in close proximity; <1 m (3.3 ft.) to lighting fixtures, heaters, skylights, or other heat-emitting objects

References

1. Fire Industry Association (FIA), FactFile No 0045, Smoke Detection in High Spaces using ASD, available at:

http://www.fia.uk.com/filemanager/root/site_assets/fact_files/fiafac_files_0045_smoke_detection_for_high_ceilings_2011_fd_aproof.pdf, April 2011 (*February 2014*).
2. Fire Industry Association (FIA), Design, Installation, Commissioning & Maintenance of Aspirating Smoke Detector (ASD) Systems - Code of Practice, Issue 3, February 2012
3. The Plastics Pipe Institute, Inc.(1999), "Suggested Temperature Limits for the Operation and Installation of Thermoplastic Piping in Non-Pressure Applications, TN-11/99". www.plasticpipe.org
4. Plastic Pipe and Fittings Association (2003) "Information & Technical Guide – ABS Plastic Pipe & Fittings. www.ppfahome.org

Prisons and Restricted Areas

Application Overview

Locked doors in buildings where occupants are intentionally restrained – such as prisons or police stations – pose significant fire and life safety risks for the facility, staff, first responders, and the individuals being restricted from exits. These types of conditions can be found in facilities that provide institutional housing of inmates on a long-term basis, as well as in small temporary lock-up facilities (airports, sports venues, police stations, etc.), that may need to detain people on a short-term basis (less than 24 hours).

Long-term facilities include prisons, jails, and other types of correctional facilities that may be known as:

- Substance abuse centres
- Community residential centres
- Local detention (lock down) facilities
- Work camps for adults or juveniles
- Correctional institutions for adults
- Training schools for juveniles

Lock-up facilities are used to provide a temporary security function for the facility, for example:

- Security offices at retail stores, sports venues, casinos, or hotel complexes
- Police station holding rooms
- Customs/immigration operations at airports or seaports
- Immigration facilities at border crossings

As shown in Figure 1 above right, fire-related goals [2] associated with detention and correctional occupancy and lock-up facilities include:

- Life safety for all the occupants (inmates, staff, and visitors)
- Property protection (in addition to the inmate cells, it may be costly to restore areas containing the control room or vocational shops, classrooms, offices, or assembly spaces after a fire)
- Business continuity (the loss of a restricted area by fire may be a concern if there is no easy solution to relocate the inmates before the fire-affected area can be used again)
- Security is a primary objective (detention and correctional occupancy facility has to maintain a secure perimeter to monitor dangerous people and protect the public and staff. The fire protection design for this type of occupancy should be coordinated and compatible with the security goal)

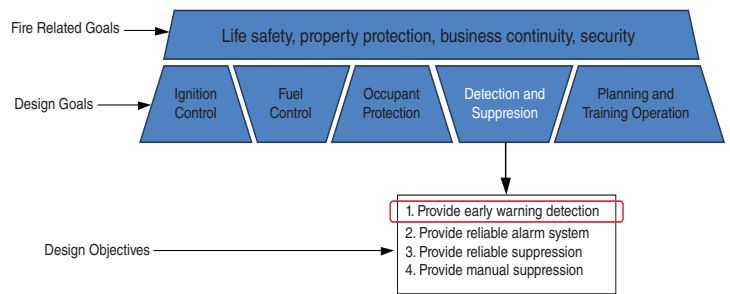

Figure 1. Fire goals, design goals, and objectives related to detention and correctional occupancy and lockup facilities

The fire-related goals are achieved through a series of design goals, as shown in Figure 1 above. For example, early warning detection is an objective or the design goal that pertains to adequate detection and suppression. Early warning detection can be essential when coupled with alarm and fire suppression, because a fire can grow rapidly and dramatically in confined areas and spread smoke to nearby spaces.

Benefits of Aspirating Smoke Detection

The “prisons and jails” category within the US National Fire Incident Reporting System (NFIRS) includes: prison cells or cell blocks, reformatories or juvenile detention homes, detention camps, and police stations. It should be noted that only fires reported to public fire departments are included in the statistics extracted from NFIRS by the NFPA [3] and presented in this section.

During the 2003-2007 period, in the US, an estimated annual average of 590 structure fires was reported for prisons and jails:

- 380 (64%) fires in jails and prisons (not juvenile), injured 29 civilians (79%), causing \$1.2 million (57%), direct property damage
- 120 (21%), fires in reformatories and juvenile detention centres injured 5 civilians (14%), causing \$0.3 million (14%), direct property damage
- 90 (15%), fires in police stations injured 3 civilians (7%), causing \$0.6 million (29%), direct property damage

No civilian fire deaths were reported during this period.

During the 2003-2007 period, in the US, structural fires in prisons and jails mainly started in the four following areas (see Figure 2 on the following page):

- Confined cooking fire (for 22% of the fires), in addition to 4% of the fires starting in the kitchen or cooking area
- Bedroom (for 17% of the fires)
- Contained trash or rubbish (for 12% of the fires)
- Laundry room or area (for 11% of the fires)

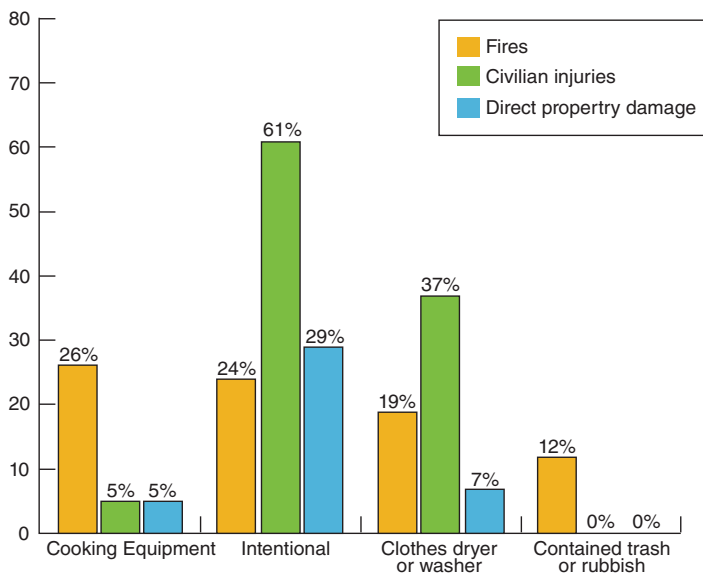

Figure 2. – Prison/Jails Fire Cause Data(US data 2003-2007);
Source: NFPA Fire Analysis and Research

It should be noted that 1 out of every 4 reported structural fires were intentional: these fires caused 61% of the civilian injuries and 29% of the direct property damage. This “intentional” statistic is not surprising, given the desire of some problematic individuals to cause disruption or vandalise the facility. Traditional smoke detection methods, such as spot-type detectors, pose a challenge in lock-up facilities, because many fire incidents occur in bedrooms or cells. Aspirating smoke detection provides effective smoke detection, while avoiding the problems associated with using other types of detectors. Aspirating smoke detection technologies can avoid or minimise the following concerns:

- Beam detectors or spot smoke detectors can be targets for malicious acts by inmates. Aspirating sampling points are visually minimal, if not fully hidden, when installed behind grills or other structural or architectural elements at the ceiling of protected spaces
- Placing an aspirating smoke detector (ASD) unit away from inmate housing and activity areas avoids testing and maintenance problems related to the detection system. When the ASD unit is located outside the inmate activity/housing zones, special security measures and disruption does not need to be implemented in order to accommodate maintenance and testing of the ASD unit
- Inmates aware of the presence of smoke detection systems, such as those located in detention cells, are often subject to tampering and false alarms. Air sampling pipe work and ASD units can be readily located to minimise visibility and the possibility of malicious tampering by inmates

Design Best Practices

Fire and life safety is achieved within locked-door institutions through the use of early warning smoke detection, automatic sprinklers, compartmentalisation, established fire zones, and a relocation plan. Building and life safety codes are cognisant of the balance needed for providing both effective fire alarm and detection systems, while minimising (if not eliminating), the potential for disruption, vandalism, and a high frequency of nuisance alarms. Both the NFPA Life Safety code and the International Building Code require detention and correctional facilities to install automatic smoke detection systems for alerting staff.

These smoke detection system requirements generally apply to the following areas of detention and correctional facilities:

1. Resident/inmate housing areas including day rooms, group activity spaces, and other common spaces contiguous with sleeping spaces. In some circumstances, detection is not required where free egress to safe compartments is provided
2. Automatic smoke detection is required in all sleeping rooms or cells with five or more occupants. Be aware that the local codes in some jurisdictions or countries may require smoke detection in all cells
3. Such required smoke detection systems are required to alarm at a constantly attended staff location but need not trigger an occupant notification (i.e., sound general alarm), or transmit a fire alarm signal to the fire department, as this procedure is typically relegated to staff

Fires are an anticipated problem within prisons, often taking place in locked cells when inmates are present. Given the small cell areas and restricted means of egress, early detection and staff response are critical for the safety of the inmates, staff, and facility operations. Smoke detector installations require special consideration in order to provide effective smoke detection, while avoiding nuisance alarms and tamper resistance. Both the NFPA Life Safety Code and the International Building Code, acknowledge this need and permit alternative installation arrangements to prevent tampering and damage, such as placing sampling points behind ventilation grills or outside inmate cells. The NFPA Life Safety Code goes one step further to require that such alternative placement or arrangement be equivalent in speed of response to otherwise standard installation practices.

If an alternative smoke detection arrangement is necessary, then aspirating smoke detection technology is a likely solution for maintaining performance in speed of response. In these circumstances, aspirating smoke detection can meet the need for fire detection and very prompt detection. Aspirating smoke detection systems can provide high sensitivity and continuously sample low quantities of smoke that may be slowly distributed and easily diluted by the airflow environment as smoke travels to an alternative sampling detection point rather than a standard location (e.g., detector on the ceiling of an inmate cell).

To minimise, manage, or control the spread of smoke in detention/correction facilities, codes will require one or more of the following features:

- Smoke barriers to divide floors into compartments, so that residents/inmates in a fire-exposed compartment, can be moved to an adjacent compartment protected against smoke spread, by structurally fire-resistant walls, doors resistant to smoke movement, and smoke dampers
- Multi-tiered, open cell blocks may require sprinklers throughout and/or smoke control systems to minimise the threat of smoke to cell block occupants
- Windowless buildings or portions of buildings where windows are not operable, not readily breakable, or not provided often require smoke control systems for a tenable environment during a fire incident or an evacuation to a safe compartment

The operational aspects of smoke barriers, such as automatic door closing and smoke damper closures, will require initiating signals from smoke detection systems. Similarly, smoke detection systems are needed to initiate smoke control features of exhaust fans, make-up air fans, and damper operations. Various types of smoke detectors could be used to initiate these critical functions; however, aspirating detection provides these initiating functions without being subject to vandalism or tampering by the inmate

population. Air sampling pipes can be run through the ceilings or other building components, well out of the reach of inmates. Sampling points and any portion of the protected rooms' piping are so minimal that they can be difficult to see.

Early detection for investigation, appropriate suppression, and inmate relocation

It should be noted that critical security objectives can cause delays while staff are investigating a fire and setting up manual fire suppression efforts (as some guards may have to relocate inmates, while others get the locked fire extinguishers). Aspiration detection can provide the time needed for security personnel to plan or conduct a controlled response – whether it's to suppress the fire/smoke source, to manually initiate emergency systems, or to evacuate a portion of the facility, which is important for protecting lives and maintaining security in the facility. ASD systems possess very early warning fire detection capabilities because some are designed to respond to the incipient fire stage (i.e., before the fire growth period), where the smoke obscuration can be as low as 0.00046% obs/ ft.. Early stage fire detection provides guards with the opportunity to investigate the fire situation and take appropriate actions regarding fire suppression and possible inmate relocation. This use of aspirating technology is consistent with the goals for security and fire safety in prisons and correctional facilities.

Risk of vandalism

Due to the needs for very early warning fire detection, it seems essential to install smoke detectors as close to the fire sources as possible, but this situation may not always be practical within the inmate living facilities.

Inmates/residents may abuse building components that are within reach, therefore generating damage and nuisance alarms. Point smoke detectors are commonly tampered with by inmates, sometimes by spraying water and aerosols or even lighting fires. In order to prevent such inconveniences and sabotage, ASD pipes can be installed out of inmate reach and sampling holes can be located in each cell return air grill, inside the HVAC system, or even concealed inside the cell itself (for example, integrated with a light fixture). With carefully planned concealment, the sampling pipes appear to be passive building features that are of no interest to inmates.

Access for accessibility, maintenance and repair

When point smoke detectors located in inmates' cells become dirty due to a lack of maintenance, it requires entering each inmate's cell. ASD system maintenance and testing are centralised on the ASD detector, which can be conveniently located outside of cells or activity areas so the whole detection system is easily accessible, safe, and quick: this ultimately reduces testing and maintenance costs as well. Remote and centralised access also allows real-time monitoring and capture of all the susceptible fire events and alarms within the detention and correctional facility, covered by one or several detectors.

Other Use/Occupancy areas

There are many different functional spaces or building sections within detention and correctional facilities, including workshops, laundries, stores, classrooms, athletic facilities, religious facilities, and administrative offices. The environment can vary significantly from that of the cell-block areas, which limits the use of traditional types of spot detectors. Aspiration detection can be installed in various areas of a facility and programmed at different sensitivity ranges. Depending on the area of use, ASD range adjustment enables aspiration systems to work just as well in machine shops or boiler rooms within the prison as they do in individual cells or common areas, while allowing for differences in air quality, humidity, temperature, and other factors. The ASD detector can be programmed so its detection thresholds vary according to the inmate activities in any area during the day-night periods. Also, frequent false alarms from point smoke

detectors are a risk due to inmate vandalism. As presented in the previous sections, an ASD system with the locations of its sampling holes, pipes, and detector can drastically decrease the occurrence of false alarms. An optional filter used with some ASD units can reduce problems associated with dirty or dusty areas (e.g., laundry rooms).

Special locations (large open spaces and ducts)

Large detention and correctional buildings may be classified as high-rise buildings, and therefore may contain large open spaces. Phenomena such as smoke dilution and smoke stratification may challenge a smoke detection system organised upon point smoke detectors. The flexibility permitted with the installation of vertical ASD pipes (combined with their very low thresholds), overcomes the smoke dilution and stratification challenges.

Lock-ups

Lock-up facilities are associated with other types of buildings and are used to provide a temporary security function for the facility. Examples of lock-up facility locations include: security offices at retail stores, sports venues, casinos, hotel complexes; police station holding rooms; and customs/immigration operations at airports or seaports; and immigration facilities at border crossings.

Lock-up arrangements are generally intended to detain individuals or small populations (50 persons or less), for a period of time not exceeding 24 hours. The fire protection features provided are those associated with the main occupancy; for example, a holding cell in a retail store would need to meet the building or life safety code provisions for a mercantile occupancy. In the case of NFPA 101, the mercantile occupancy requirements are allowed provided that staff is trained, authorised, and in proximity to lock-up so that locked doors or other restraints can be readily released (within 2 minutes), to allow for occupant evacuation in the event of a fire or other emergency. If just one of the related staffing requirements cannot be met, NFPA 101 then requires the lock-up to be provided with a complete smoke detection system and fire alarm system for staff and occupant notification. Just as in full-time prisons or jails, aspiration smoke detection can provide the time needed for security personnel or other staff to respond to a fire emergency in the lock-up area and unlock the doors or other restraints so occupants can move to safety or exit the facility.

Common Issues/Application Troubleshooting

Aspirating smoke detection (ASD), has many benefits and the programmability of a remote detector make it a suitable detection system for a restricted access configuration. However, there are several considerations for the use of ASD within this type of configuration. During the design phase the following factors should be considered:

- The sensitivity levels and alarm thresholds should be as low as possible, in order to detect the smallest production of smoke (considered here as a contaminant more than a fire effluent), to allow fire investigation by the guards
- The designer needs to verify the air-flow and direction of air within the space to maximise the systems effectiveness. The sampling points should be installed in the direction of the air-flow, especially in the air return ducts
- For large detection system with many sampling holes the designer needs to take into consideration smoke/air dilution. The more sampling holes the air sampling pipe contains, a greater volume of air is returning to the aspirating detector; this can dilute the quantity of smoke within the detection chamber and may delay the time the quantity of smoke necessary to initiate an alarm, is present within the detection chamber.

- The location of the sampling holes within the detection network is a concern. The further the sampling hole is located from the aspirating smoke detector the more air/smoke dilution occurs; which could delay the time the quantity of smoke necessary to initiate an alarm is present within the detection chamber
- Special care will be given to the design of air sampling pipes as well as sampling hole locations and spacing for large open space and duct applications

Programming consideration of the aspirating smoke detector during commissioning process

During the commissioning process the installing contractor needs to properly program the alarm thresholds and sensitivity levels. These programmable sensitivity levels and alarm thresholds could significantly impact the performance of the aspirating smoke detector. The following programming considerations should be considered:

- Typically, aspirating smoke detectors are shipped with default settings from the factory. These settings are not appropriate for all detection systems. These settings are to be considered generic and may not be sensitive enough, or too sensitive for a specific application. It is necessary for the ASD designer to determine the alarm levels and program the sensor accordingly. The sensitivity levels and alarm thresholds are derived by a combination of the computer based calculation program, the hazard being protected, detection system size and engineering judgment
- Another significant issue that will impact the performance of aspirating smoke detection systems is the programmable sensitivity levels. The detectors contain sophisticated electronics and software that allow the device to be programmed to a wide range of sensitivity levels. If these alarm levels are not programmed properly the quantity of smoke necessary within the sensing chamber may exceed the desired sensitivity causing a delay in the initiation of an alarm signal

Time delays for initiating further actions

Also included are time delays for the activation of the trouble and alarm signals at the detector. These delays can be set for a range of times, typically ranging from 10 - 30 seconds. Consideration should be given when programming the time delays. The greater the delay the longer it will take for the detector to initiate an alarm signal.

Dos

- Refer to the appropriate sections of ASD application guides for:
 - Large and open spaces (for ASD sampling of multi-tier cell blocks and high ceiling areas)
 - In-duct (for ASD sampling of HVAC ducts)
- Identify applicable codes and related requirements and performance criteria specified for fire detection systems. NFPA 101 or applicable local codes
- Identify and understand the air handling features and air flow paths. Aspirating detection systems have the sensitivity and fast response capability to detect threatening smoke contamination in the air flow path at the earliest opportunity
- Identify and understand any smoke control and/or pressurisation schemes that need to be implemented upon smoke detection.

Using associated outputs of air aspiration detectors, important smoke control functions can be promptly initiated.

- Confirm and implement how the alert settings and fire alarm settings of aspirating systems are to be integrated to initiate the following if applicable: 1) fixed fire suppression systems, 2) security staff response, 3) smoke barrier associated smoke damper or door closures, 4) smoke control and room pressurisation operations.
- Transmit alarms from aspirating smoke detection to a constantly attended location.

Don'ts

- Don't exceed the recommended detector or sampling point spacing of applicable standards.
- Don't use detectors that are not listed or approved for air velocities and temperatures that will be encounter in the airflow paths of protected spaces
- Don't design the aspirating system to exceed the transport time requirements of installation standards or insurance company requirements

References

1. NFPA 101 "Life Safety Code", 2012 edition, National Fire Protection Association
2. Flynn, J.D., Prisons and Jails, NFPA Fire Analysis and Research, Quincy, MA, March 2010.

Section 11

Extreme Temperatures

Application

Environments with extreme temperatures – such as cold storage facilities or confined data centre aisles – are among the most challenging to protect from fire and smoke damage. This presents a problem if detection systems are required, because traditional heat and smoke detectors are listed for a normal ambient operating temperature range of 0° C - 38° C (32° F - 100° F); therefore, modern codes will not allow these devices to be installed in areas that are below 0° C (32° F) or above 38° C (100° F). Alternate detection methods are required for atmospheres that exceed these temperature ranges.

The installation of fire detection and suppression systems is essential in such facilities, but traditional detection methods cannot be installed due to the extreme environment conditions.

ASD units are well-suited for extreme conditions. The ASD unit has the same installation constraints as traditional smoke and heat detectors, except that it's listed for installation in areas with an ambient operating temperature between 0° C (32° F) to 38° C (100° F). However, the ASD does not have to be located inside the protected space because only the sampling pipe is exposed to the extreme temperatures. Heating elements, pipe lagging, or extended pipe length may be required to heat the sampled air within ASD limits, depending on the temperature of the air being removed from the room. A condensation trap can also be installed to trap moisture before it enters the device.

The ASD does have limitations when protecting extreme climates. The temperature of the air that passes through the sampling chamber is required to be between -28° C (-4° F) to 60° C (140° F); check with the specific manufacturer's listing prior to installation to verify operating temperature ranges and design methods.

Condensation may accumulate on the inside of the sampling pipe when working in atmospheres with significant temperature and humidity differences, particularly in hot aisle containment areas. Condensation is the change of state of a gas (air) to a liquid (water), and is most often caused when the gas is transported from a warmer area to a cooler area.

Cold Storage Facilities

Cold storage facilities (where refrigerated or frozen products are kept prior to final use), are subject to extreme environmental conditions. Ambient temperatures can range from -40° C (-40° F) for a freezer, to -5° C (41° F) for a chiller or cooler (see Figure 1 below).

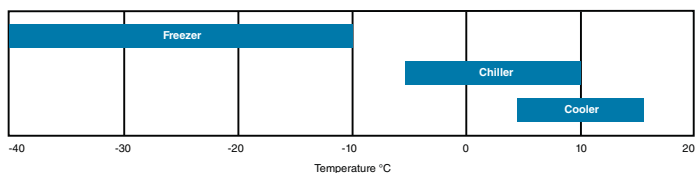

Figure 1.. Temperature ranges for freezer/chiller/cooler

High airflows and the absence of humidity further complicate fire protection for cold storage facilities and impact the response of traditional detectors. Heavy combustion load is another concern for cold storage facility protection. Large quantities of highly combustible materials are stored, including:

- Wooden pallets for stacking product
- Plastic product packaging
- Cardboard boxes for the storage of product
- Small forklifts used to move product in and out of the facility
- Polyurethane or polystyrene foam insulation used in the walls and ceiling

Stored commodities are combustible, and generated heat could easily transfer to them in the event of a smouldering fire. Research conducted on stored warehouse commodities found a 2 x 2 x 2 pallet array of packaged fruit/berry baskets produced a peak heat release rate (HRR) of 8,695 kW within approximately 600 seconds after ignition. This is a significant amount of heat being released from the pallet array, and could easily ignite pallets of adjacent materials.

Cold storage ignition sources include, but are not limited to:

- Small forklifts powered by LP, LNG, or electrically
- Conveyor or other type of mechanical systems used to transport the product
- Electrical spark or short from lighting or improperly grounded equipment
- A fire caused by the workers (such as a discharged cigarette or improper use of a torch or welder)

Between the heavy combustion load and potential ignition sources, cold storage fire protection is critical. The sooner a fire is detected, the better the chances of saving stored goods.

Water-based sprinkler systems are commonly installed in cold storage facilities to provide overall structure protection. Due to the extreme temperatures, a traditional wet pipe sprinkler system cannot be installed. Most cold storage facilities are protected by a double inter-lock, pre-action sprinkler system. As the term implies, the pre-action system is interlocked with a detection system and requires the activation of both a detection system and an individual sprinkler to discharge water into the area.

Traditional detection systems also use heat detectors, located at the ceiling level and within racks and flue spaces. Heat detectors typically have a temperature rating between 57° C - 68° C (135° F and 155° F), so fire could potentially damage the product or activate the freezer suppression system by the time sufficient heat is present to activate a detector.

It should be noted that water-based sprinkler systems have limitations and present challenges in the event of a system discharge. To minimise damage and potential loss in cold storage facilities, the presence of smoke and/or heat must be detected at the earliest possible stage.

Benefits of ASD in Cold Storage Facilities

ASD units provide early warning by detecting smouldering fires before they become flaming fires. Earlier detection allows occupants more time to respond and possibly extinguish fires prior to sprinkler system activation, avoiding extensive clean-up and downtime.

An ASD units' normal operating temperature is typically outside the listed ambient operating temperature range for extreme environments. An ASD can be mounted in a non-refrigerated space where only the sample pipe is installed in the refrigerated area.

The device must be mounted outside of the room and the pipe network run in to the protected space. Depending on the temperature of the air being removed from the room, heating elements may be required to heat the sampled air to above the listed temperature.

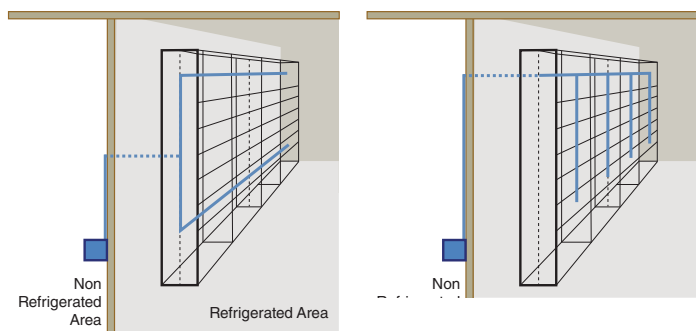

Figure 2. ASD unit installed in void, non-refrigerated space

A condensation trap is also installed to trap any condensation or moisture before it enters the device.

ASD Unit Location

The ASD unit is located in a void or non-refrigerated space and only the sampling pipe is installed in the cold storage, See Figure 2 above for an example of ASD mounting in a rack installation.



Figure 3. Typical sampling pipe ceiling mounting clips

Pipe Design and Material

When designing a sampling pipe system for a freezer or cooler, several items need to be taken into account during the installation. The sampling pipe can be attached directly to the ceiling utilising the mounting clips (shown in Figure 3 above), but the installer needs to verify the clips are listed for installation in atmospheres with the associated ambient temperatures, and that the sampling pipe can be installed in storage racks (see Figure 2 above).

The sample pipe for a cold storage application should be selected based on local codes as well as the lowest temperature expected for the space. CPVC and PVC are commonly used for sample pipe materials outside of the cold storage space, but neither is capable of withstanding the extreme subzero temperatures of freezers operating below -20°C (-4°F). ABS, PE,

copper, and stainless steel pipe (of appropriate size), can all withstand extremely low temperatures, making them acceptable for cold applications below -20°C (-4°F). Copper and stainless pipe have the added advantage of enabling the installation of heat tracing cable along the pipe outside the space (see "Heat Tracing" for more information).

All metallic pipe should be properly grounded to avoid the common static build-up associated with continuous airflow. Plastic pipe must be used at the ASD unit intake and exhaust ports for a proper seal with the ASD unit. Never cement sample pipe to the ASD unit itself.

Table 1 - Pipe Temp. Ratings

Pipe Material	Service Temperature
ABS	-40°C - 80°C (-40°F - 176°F)
PE-80	-50°C - 60°C (-58°F - 140°F)
PE-100	-50°C - 60°C (-58°F - 140°F)
CPVC	-26°C - 93°C (-15°F - 200°F)
PVC	-26°C - 49°C (-15°F - 120°F)
COPPER	-150°C - 110°C (-238°F - 230°F)

Best Design Practices for Cold Storage

Once temperature-appropriate pipe has been selected for the cold storage application, several guidelines should be followed to design a sampling pipe network.

First, the sampling pipes should be kept out of chiller units' immediate supply airflow; the temperature at these locations can be 20° cooler than the room itself. The sampling pipe should also be kept away from large overhead doors that allow warm air into the cold storage facility.

Whatever the application, pipe condensation will occur on any surface that drops below the dew point temperature. Pipe clogs caused by condensation or frosting on the Internal Diameter (ID), of the pipe will only occur if the pipe experiences a drop to the dew point temperature somewhere along its length. This dew point temperature is often a few degrees below the cold space operating temperature, so every effort should be made to keep the pipe away from local temperature fluctuations within the space.

Sampling Hole Spacing and Orientation

Cold storage applications have unique challenges when determining the location and orientation of the sampling holes. Due to the extreme nature of the space, there are more limitations because condensation and frost conditions can impact the sampling pipe and sampling hole locations. The following provides further guidelines for designing ASD pipe networks and sampling holes for cold storage applications:

- Freezer thru-traffic and other conduits for added moisture can quickly raise relative humidity levels, resulting in condensation and frost issues within a sub-zero application. This added moisture in the air will first and foremost show as frost around sample holes, near the doorway or supply vent (areas to be avoided during pipe design)

- Position all sample holes facing sideways in freezer applications. Sample holes facing the floor are more prone to frost build-up and clogging if moisture collects within the pipe
- Space sample holes appropriately to avoid the warm, moist air entering from access doors. Sample holes nearest these locations should face away from the access door and be no smaller than 3 mm (0.125 in) diameter
- Sample piping and sampling holes should not be positioned in the vicinity of the supply air stream. The supply air for cold storage can be 20° cooler than the cold space's normal operating temperature

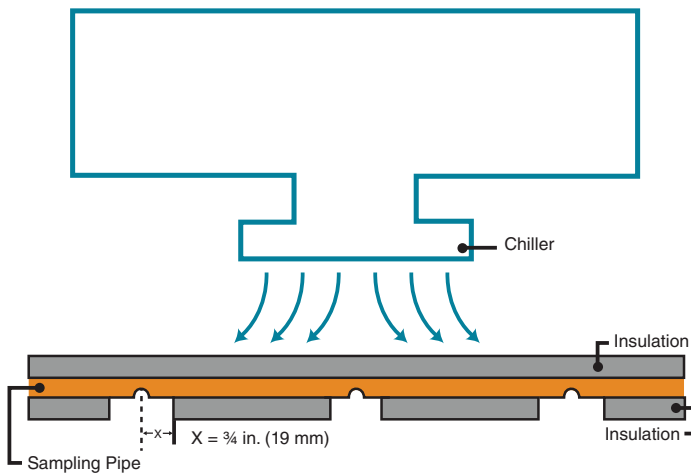

Figure 4. Sampling pipe installed in the vicinity of a large chiller unit.

- Pipes mounted in front of the cold air supply can experience frosting at sample hole locations. Any sample holes located within the vicinity of the supply air should be at least 3 mm (0.125 in.) diameter and face 90° from the floor. Wrapping the pipe in insulation at this location can help avoid frost on the pipe's inner diameter. If insulation is installed, leave a 20 mm (0.75 in.) gap in the insulation at the sample hole location. The insulation must then be fastened in place with hose clamps to prevent it from moving and covering the sample hole. Sample holes in these locations should be no smaller than 3 mm (0.125 in.) diameter
- Where possible, sample holes should be placed near the return air location of the cooling unit. The cooling unit will actively pull air over the sample hole. The sample holes should be positioned on the side of the pipe facing into the direction of flow
- Capillary sample tubes should be avoided in cold storage due to smaller tube diameter and the downward-facing sample holes

Pipe Locations

Sampling pipe can be installed on the ceiling and within storage racks

Pipe Traps

Pipe traps are often installed outside the space to protect against moisture build-up. Condensation rarely occurs on the inside surface of a pipe when it exits the cold space; however, when the cool, dry air is warmed outside the cold space, its dry bulb temperature is warming and moving further from the dew point temperature. The dew point temperature is based on the moisture content in the cold space, and remains constant as the air warms along the length of the pipe. Condensation will only occur if the sample

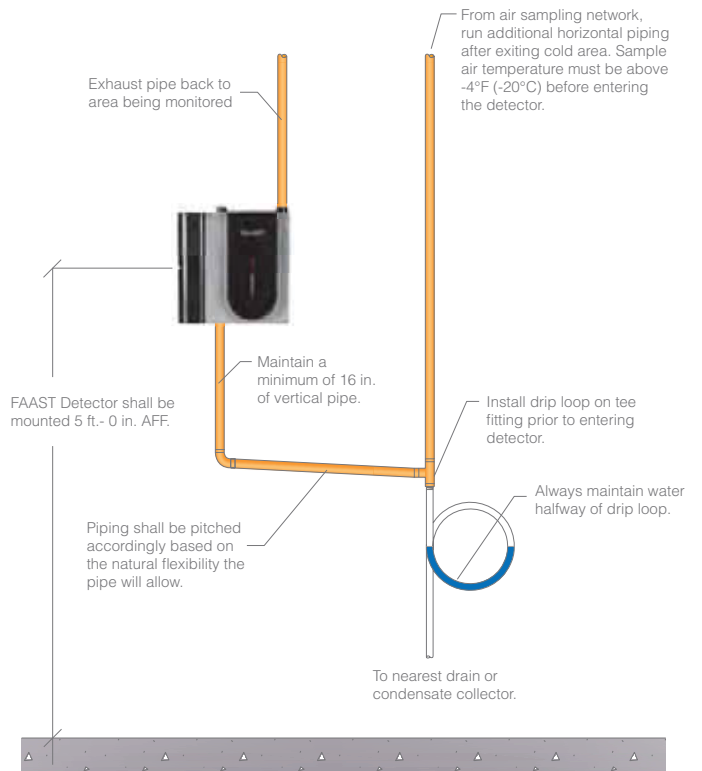

Figure 5. Typical pipe trap

pipe experiences a drop in temperature below that of the cold space itself. This drop in temperature can happen if the sample pipe is located near an outside door in the winter months (see Figure 5 above).

Pre Heat

Sample pipes exiting cold storage must be long enough to ensure the air temperature inside the pipe is 0° C (32° F) or higher when it reaches the

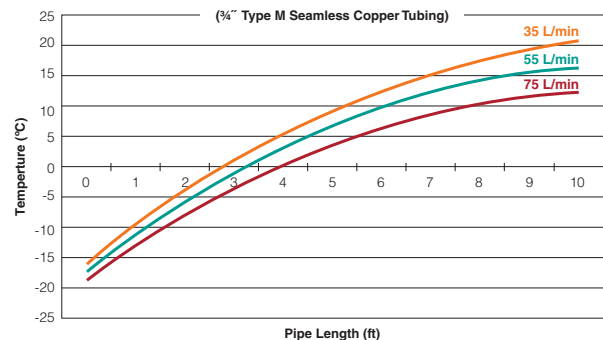
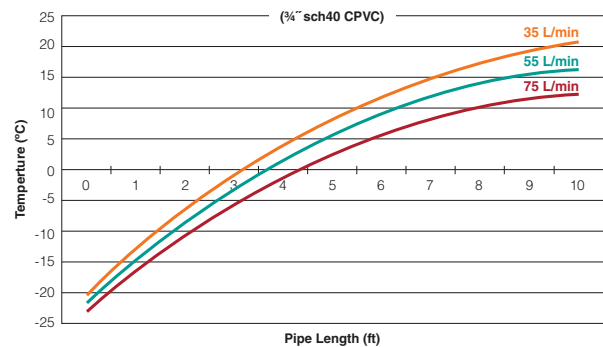

Figure 6. Distances needed to heat air in sampling pipe

ASD and sampling chamber, as required. An external heater cable can help raise the temperature if the external pipe length is too short to warm the air prior to the entering the ASD, or if condensation on the exterior of the pipe causes moisture-related issues.

The use of heat tracing may be required when the sampled air temperature does not have sufficient time to warm to above -28°C (-4°F) before entering the sampling chamber. Heat trace (or heater cable), is a low-power cable capable of warming pipe sections, when it's necessary to warm the air to above the listed temperature.

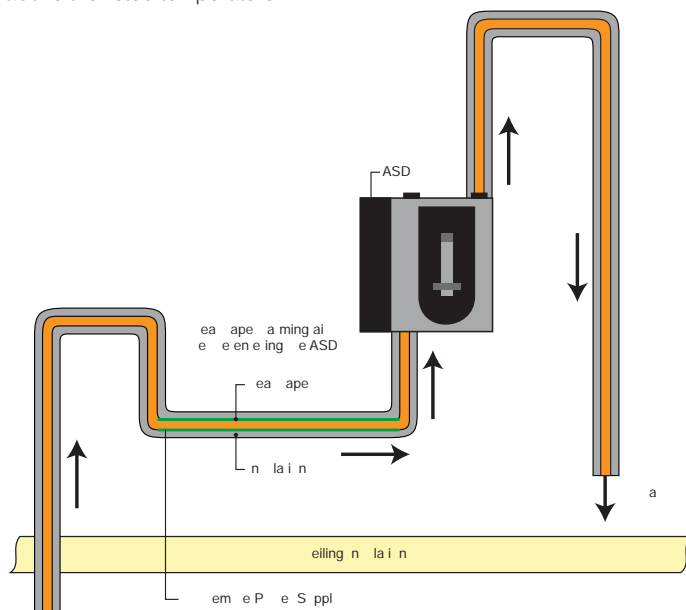

Figure 7. Heat trace installation

The typical heat trace cable is attached to the sampling pipe and requires a supplemental power supply to provide the necessary heat. The installation of a low-power heater cable can minimise the required length of pipe, and provide added security against condensation, both inside and outside the pipe external to the cold space (see Figure 7 above for typical heat trace installation).

Wall and Ceiling Penetrations

All wall penetrations must be well-sealed against long-term air leakage. Otherwise, moist outside air will migrate into a freezer through the smallest of leaks and condense, causing ice formations.

Avoid vertical pipe penetrations in cold storage facilities. Cold air will carry airborne ice particles up through the vertical pipe while leaving a freezer; the ice particles will melt on the pipe's inside wall when it warms outside of the freezer space. The melted ice will then drip down the inside surface of the pipe and back into the freezer, where it will freeze and eventually create a pipe blockage condition.

If penetrations are made in the ceiling, then the hole should be drilled only large enough to fit the sampling pipe. The section of the pipe that penetrates the roof should be sealed with a urethane foam material, and then the penetration area and insulated panels on both sides of the ceiling need to be sealed with sealants rated for the in-unit temperatures.

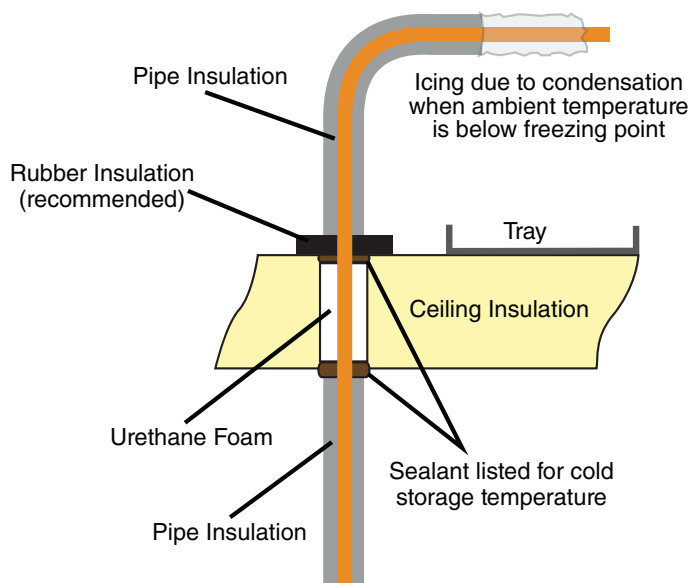

Figure 8. Ceiling insulating pipe

For ceiling penetrations, a metal tray should be installed under the ASD sampling pipe to catch water droplets or ice that may form on the pipe. This protects the cold storage facility's roof from possible damage. (see Figure 8 above, for typical penetration into ceilings and walls).

Capillary Sampling

If possible, avoid installing capillary sampling tubes in cold storage facilities. This method requires multiple ceiling and wall penetrations through the insulating material, and minimal penetrations should be made to maintain the integrity of the cold storage facility. The chances of a leak increase with more penetrations to the insulation. If warm air starts to leak around the sampling pipe or capillary tube, condensation could result in an ice blockage in the small diameter capillary tube. For capillary sampling, refer to Figure 9 below.

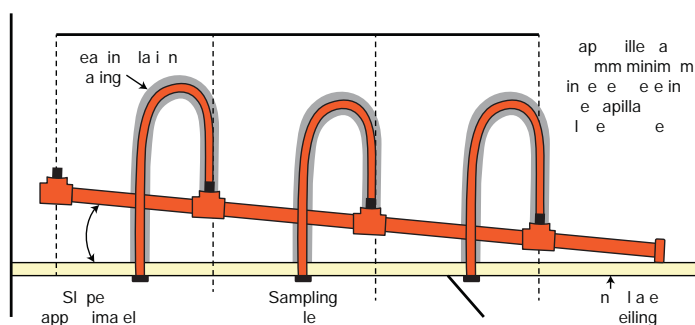

Figure 9. Capillary installation methods in cold storage

Pipe Support Spacing

Figure 10 below provides sampling pipe support spacing recommendations based on diameter and material.

Pipe Material	CTE 1/°C (1/°F)	Resultant Pipe Expansion mm/10m x 10°C (in/100ft. x 10°F)	Max Support Spacing m (ft.)
ABS	9.8 x 10 ⁻⁵ (5.5 x 10 ⁻⁵)	9.8 (0.66)	1.2 (4)
PE-80	20.0 x 10 ⁻⁵ (11.0 x 10 ⁻⁵)	20.0 (0.41)	1.2 (4)
PE-100	13.0 x 10 ⁻⁵ (7.3 x 10 ⁻⁵)	13.0 (0.88)	1.2 (4)
CPVC	6.1 x 10 ⁻⁵ (3.4 x 10 ⁻⁵)	6.1 (0.41)	1.4 (4.5)
PVC	7.0 x 10 ⁻⁵ (4.0 x 10 ⁻⁵)	7.0 (0.48)	1.4 (4.5)
Copper	0.5 x 10 ⁻⁵ (0.9 x 10 ⁻⁵)	0.5 (0.11)	1.5 (5)
Stainless	0.4 x 10 ⁻⁵ (0.7 x 10 ⁻⁵)	0.4 (0.08)	1.5 (5)

Figure 10. Pipe support spacing

Common Issues/Application Troubleshooting

ASD can often provide a solution for cold storage spaces, but all temperature, airflow, condensation, and pressure differential issues must be considered and resolved prior to installation.

Frost Effects

Defrost cycle time and frequency varies for cold storage locations. Generally, defrost cycles occur 1 or 2 times per day for a period of 20-30 minutes. The heat applied during the defrost cycle is local to the evaporating coil of the unit and therefore has little-to-no effect on the cold space itself, or on the performance of the ASD unit.

Pipe Thermal Expansion

Thermal expansion of the pipe network must be considered in cold applications. Pipe hangers must allow the pipe to move freely wherever possible. Expansion joints or flexible pipe should be used in locations that would otherwise not allow for expansion or contraction, including areas that require the pipe to be clamped (refer to the expansion joint shown top right in Figure 11). The size of an expansion joint is based on the low temperature modulus for the chosen pipe material

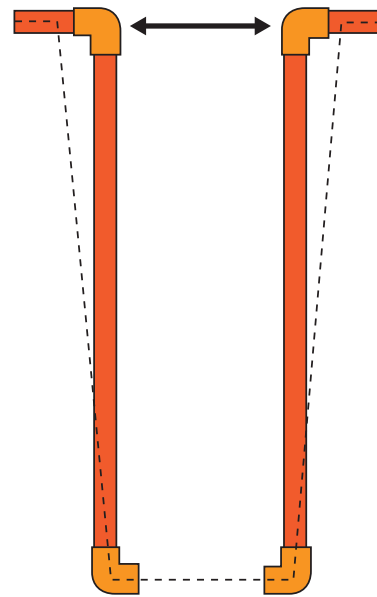

Figure 11. Joint expansion

Example: A 50 m (164 ft.) run of ABS pipe installed at 22° C (72° F) in a freezer that drops in temperature to -20° C (-4° F) would contract 205 mm (8.1 in.).

This type of contraction can easily cause a leak in a pipe network if no provision is given for pipe movement. The final check for pipe integrity (leaks) should be done at operating temperature.

Typical Hot Aisle Containment Application

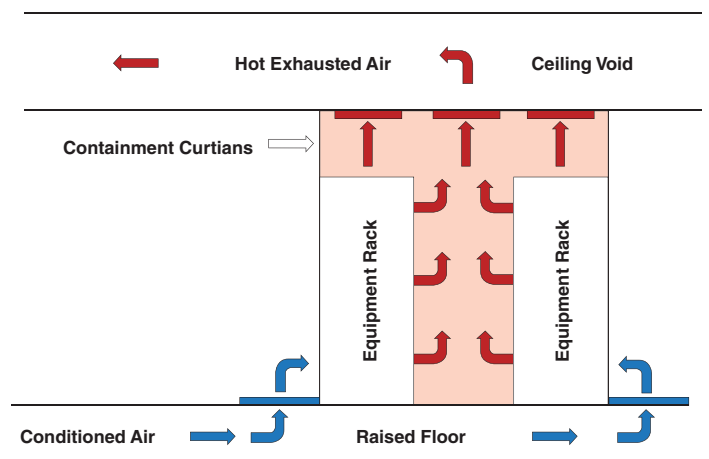

Figure 12. Typical hot air aisle containment configuration

Hot Aisle Containment Area

Hot air containment spaces in data centres trap the exhausted air to cool computer mainframes and racks (see Figure 12 on the previous page).

Once contained, the air is transported back to the HVAC systems for conditioning. The temperatures inside a hot air containment space can range between 27°C - 48°C (80° F - 120° F). In most cases, the ambient temperatures are either close to or exceed the upper-listed rated temperature for traditional detection devices. As a result, most traditional spot-type smoke detectors cannot be installed within the hot aisle containment space.

Hot containment space temperatures may be above the listed ambient operating temperature, which means an alternate detection method is necessary. It is common to have fire protection systems that require a detection system to operate, such as automatic sprinkler systems, precaution sprinkler systems, or gaseous extinguishing systems.

As the hot air is drawn out of the hot containment space and transported to a space with a 17° C - 27° C (30° F - 40° F) temperature difference, condensation may form inside the sampling pipes. Install a pipe trap on the piping network to prevent water droplet formation and avoid ASD unit damage or disruption. Refer to Figure 5 on page 67, for the pipe trap configuration.

For further information concerning the protection of hot aisle containment spaces, refer to the Data Centre Section of this application guide.

Dos

- Identify applicable codes and insurer's requirements
- Create as few penetrations in the cold storage facility as possible
- Properly seal all penetrations to avoid condensation and the build-up of frost
- Ensure all sampling pipe connections are tight
- During the installation process, properly compensate for thermal expansion and contraction of the sampling pipe when the pipe is at operating temperatures

Design Considerations

- Install FFAST in a area above 0° C (32° F)
- Sample air prior to reaching the detector shall be above -20° C (-4° F)
- Avoid placing piping or sample ports less than 3 ft. from supply vent
- Avoid using capillaries when possible
- Use silicon spray around sample ports
- Avoid sample ports relatively close to entry doors to avoid dew point temperatures causing condensation

Design Considerations

- Add additional runs of piping to warm the air or insulate pipe using heat trace cable
- Use appropriate piping that is listed with freezer temperature
- Provide insulation if cold air is directly impacting the pipe
- It is recommended to install the piping within the freezer. Pipe shall penetrate the side of the freezer to avoid vertical pipe drops
- All penetrations should be properly sealed with a foam sleeve around the pipe and silicon on both sides of the opening

Don'ts

- Don't install sampling pipe near chiller inputs
- Don't install sampling pipe near large doors that allow warm air into the cold storage facility
- Don't install system to sample different cold storage facilities that have different operating temperatures

Dirty Environments

Application Overview

A wide range of environmental conditions are encountered in industrial/manufacturing facilities: some environments may be controlled and clean, while others may present dusty or dirty conditions during normal operations. Often, the process and equipment that contributes to the dusty/dirty condition requires an Early Warning Fire Detection (EWFD) strategy. The combination of industrial or manufacturing downtime and the replacement cost of the equipment, makes fire detection an extremely important consideration. Aspirating smoke detection technology provides fire detection that can not only withstand dirty or dusty environments, but also offer effective early warning, without the false alarms and process shut-downs. For many of these facilities, a small fire incident detected early by aspirating smoke detection can result in the response needed to prevent a large fire or explosion, loss of human life, and financial distress.

Dust is common in industrial or manufacturing environments, due to the presence of coal, wood, or by-products of the process. Conventional spot-type smoke detectors are counterproductive in these types of environments for two main reasons. First, traditional spot detectors cannot distinguish between dust and dirt particulates and products of combustion, which significantly increases the occurrence of nuisance alarms. Second, dust and dirt particulates can accumulate inside the spot-type smoke detector and cause "dirty" detector warnings. Large dust particles can also damage the electronic components of traditional smoke detectors, which adds to costs, because frequent unit replacement may be required. These factors make the installation of traditional spot-type smoke detectors impractical in harsh environments.

The ASD system provides a practical and extremely effective alternative for dirty environments, because the sampling pipe is located in the protected space. The sampled air collected at the ASD unit passes through a filter to remove particulates that would damage the sophisticated internal components differentiating between smoke and dust.

Protected facility types include:

- Waste Handling Centres
- Zoos and Animal Stables
- Industrial/Manufacturing environments

Benefits of Aspirating Smoke Detection

ASD units provide early warning to detect products of combustion in the early stages of fire growth. Earlier annunciation provides more time to respond and possibly extinguish the fire before it spreads to other areas. The ASD system has three significant advantages over the traditional spot-type smoke detection system:

1. The electronics within some ASD units can distinguish between dust and dirt particles and smoke particulates, which increases reliability and decreases the potential for nuisance alarms
2. ASD units are sensitive enough to detect smoke particulates in the fire incipient stage. ASDs can detect fires before flames are visible, because of the active detection and the programmable sensitivity alarm levels. This allows for greater response time for on-site personnel

3. ASD units are mounted in a "clean" environment where only the sampling pipes are subjected to harsh conditions. In most ASD units, the sampled air passes through a filtering system prior to entering the sensing chamber. The filter removes the large particles that could damage the sensing unit, making it cost effective

Use caution when installing an ASD unit in dusty environments. Dusty environments like coal mines are often explosive in nature and may require Intrinsically Safe (IS) devices; not all ASD units are listed or approved for these atmospheres. Refer to manufacturer's listings and approvals whenever installing ASD units in these types of environments.

Best Design Practices

Certain precautions must be taken when installing an ASD system in a dirty or dusty environment.

Additional Filters

It is sometimes necessary to install an additional filter on the sampling pipe, before it enters the ASD unit. This can filter a larger number of particles that would interfere with the ASD unit's operation (See Figure 1 below). Refer to the manufacturer's installation guide for approved filters and their installation.

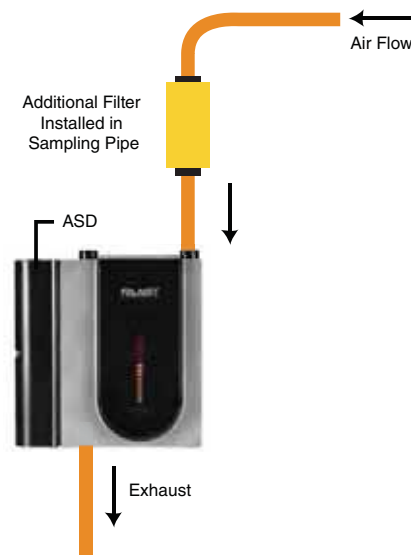

Figure 1. Additional filter installed on the sampling pipe of the ASD system

Reference Detector

In waste handling facilities that burn solid waste to generate fuel, it is common for particles and smoke produced by combustion to escape from the incinerator during normal operation. If this type of smoke is injected into the protected space and sampled, it could potentially cause a nuisance alarm. To avoid nuisance alarms and to account for the period rise of the ambient smoke level, a Reference Detector (RD) can be installed. The reference detector is programmed separately from the other ASD units:

- The RD continuously samples air from outside of the protected areas and produces a background reading of smoke and particles for this air
- For all the ASD units connected to the network, the internal software of each ASD unit subtracts the RD background reading from the ASD readings within their protected areas. If the resulting reading difference is above the programmed sensitivity levels, the corresponding ASD units activate an alarm

Drip Loop

Industrial environments also may have significant temperature and humidity differences between the sampled space and the installed ASD unit space, which means condensation could be a concern. To prevent moisture from getting into the ASD unit and damaging the sensing chamber, it may be necessary to install a drip loop to allow the moisture to condense, before it enters the ASD sensing chamber. See Figure 2 below for the installation of a drip loop in the sampling network. If there is an extreme temperature difference, refer to the Extreme Temperatures section of this application guide for further guidance.

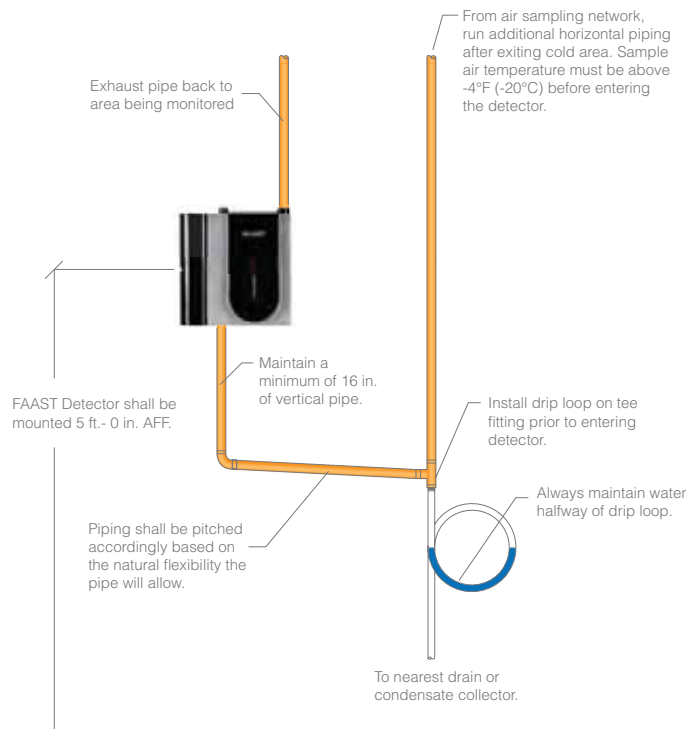

Figure 2. Drip loop installed in sampling pipe

Waste Handling Centre

After a product has served its purpose for the user, the remainder is discarded as waste. The material is brought to a Waste Handling Centre (WHC), for processing (see Figure 3 below). The Raw Municipal Waste (RMW), is typically transported to the WHC by truck, and dumped onto a



Figure 3. Waste on a tripper floor before recyclables are separated

tripper floor or waste pit; a large open space where the waste is collected and the separation process begins.

Once on the tripper floor or in the waste pit, the RMW is separated from the recyclable materials; plastics, metal, and glass are separated from the wood, paper, cardboard, and ordinary trash. The recyclable materials are then transported to the appropriate industry recycling centre and the ordinary trash is processed in several methods, including:

- Compacted and sent to a landfill
- Sent directly to incinerators to generate steam to turn turbines or create hot water
- Processed to create a refuse-derived fuel (RDF) (1). These processes include a reduction in size and drying the product. In many cases the waste is compacted to pallet or other similar form

As landfill space becomes more limited, more of the waste is being used as an energy source and converted to RDF.

When the RMW is on the tripper floor or in the waste pit, it presents significant fire hazards. Much of the RMW contains small amounts of hazardous waste in the form of aerosol cans and traces of hazardous chemicals from improperly discarded household cleaners, paint, and similar chemicals.

Fire protection is difficult in waste handling centres due to the extremely heavy flammable load and its distribution over a significant floor area. Housekeeping is particularly important due to the heavy fuel load and the numerous ignition sources. However, early warning of a potential fire is important when there is such a significant fuel load distributed over a large floor area. Ignition sources range from:

- Sparks from metal products during loading and while moving the RMW on the tripper floor or in the waste pit
- Vehicles used to process the waste. In many facilities, small gas, LNG, or propane-powered vehicles are used to move the RMW
- Welding or cutting torches used in vicinity of the RMW
- Carelessly discarding cigarettes or other smoking materials

Beam-type smoke detectors are used to detect smoke in the open areas of many applications. However, if these types of detectors are hit or become misaligned, they can generate nuisance alarms or troubles.

In an ASD system installation, the sampling pipe is extended into the open tripper floor or waste pit and the ASD unit is installed in a clean location. The large dust and dirt particles can be filtered out by either (or both), an external or internal filter that samples the smaller dust and smoke particulates in the sensing chamber. The following are the best locations for the sampling pipe:

- At ceiling-level, clear of all moving equipment
- At exhaust grills to monitor the air as it leaves the space
- Vertical sampling (similar to warehouse sampling), if the space is open with a tall ceiling
- If an incinerator is present, a reference detector may be necessary or the auto-learn feature utilised during commissioning to minimise nuisance alarms.

Zoos and Animal Stables

Fire protection is critical in zoos, horse barns, and animal stables (see Figure 4 below), but it's difficult to provide with traditional detection. Many zoo animals are dangerous and cannot be readily relocated in the event of a fire, or released in the open to fend for themselves.



Figure 4. Animals in captivity and horse barns

It's therefore critical to provide zoo keepers and trainers with sufficient reaction time.

These facilities traditionally have a high combustion load due to the use of hay for a food source and straw for bedding. Many horse stables are constructed primarily of wood, which only adds to the already high fuel load. A single spark can cause a fire to smoulder for long periods of time until the material produces a flaming fire.

The fuel sources in these areas allow fire to spread rapidly, and they're capable of rapidly destroying a structure. There are many solutions to assist in minimising the fire risk and to limit the ability of the fire to spread:

- Store hay and straw in a separate building and only bring in the amount that will be used
- Remove all non-essential flammables, such as paint and rags
- Keep the area clean and free of easily ignitable flammables, such as dust and cardboard boxes
- Remove all possible ignition sources such as smoking materials, heaters, and machinery

NFPA (3) defines different areas of facilities that house animals as:

- A Class 1 facility is an area of a building that houses animals with no general public access
- A Class 2 facility is an area of a building that houses animals with restricted general public access
- A Class 3 facility is an area of a building that houses animals with regular general public access

Table 1 below outlines the requirements from a fire alarm system in the different classes of facilities that house animals.

Table 1. NFPA Zoo Fire Alarm Requirements

Facility Class	Fire Alarm Requirements
Class 1 with a total area < 280 m ² (3,000 ft. ²)	A Local fire alarm system
Class 1 > 930 m ² (10,000 ft. ²)	A monitored fire alarm system
Class 2 < 280 m ² (3,000 ft. ²)	A Local fire alarm system
Class 2 > 930 m ² (10,000 ft. ²)	A monitored fire alarm system
Class 3	A monitored fire alarm system

Table 1. NFPA Zoo Fire Alarm Requirements

Many of these environments are not conducive for spot-type smoke detectors. However, ASD systems can provide the required detection for dirty atmospheres that cause nuisance alarms or constant "dirty" detector signals. Since the unit is outside the protected area, it can also prevent tampering or accidental destruction.

The ASD unit is located outside of the dirty environment and the sampled air is transported back to the unit via the sampling pipe network. For most ASD units, the air passes through a filter to remove all the large particulates that may damage the electronics and initiate nuisance alarms. The best sampling pipe locations are:

- Installed as an open air detection system
- Concealed in features of the cages or habitat to avoid tampering or damage by the animals. This may be a particular concern with primate habitats and aviaries
- Located outside the cages or habitat, where capillary tubes are used to sample the cage or habitat air while concealed sampling pipes are installed
- Associated with in-duct and return air sampling: most areas that house animals indoors have frequent air changes to provide fresh air and reduce the accumulation of odours. ASD systems installed within the return and supply air ducts, provides a method to detect the presence of smoke earlier than duct spot type smoke detectors.

Installing ASD systems in zoos can greatly reduce the maintenance time. A test sampling point can be installed outside of the animal habitat or cage in an accessible area, and most of the time the fire alarm technician does not need to enter the animal containment areas. This eliminates the need to relocate or disturb animals during annual maintenance and simplifies the testing process.

Make sure the proper sampling pipe and installation method is chosen whenever installing an ASD system in these environments. For primate cages and habitats, the sampling pipe may need to be constructed of metal and welded to the ceiling to avoid tampering and ultimately being destroyed by the animals. Consult the ASD system manufacturer, AHJ, and insurance underwriters prior to installation for approval of any system that deviates from the industry standard. Refer to the manufacturer's installation manual and design software for the type of sampling pipe that can be used in this application.

Animal cage areas are frequently cleaned by spraying down the entire space with a hose; there may be high humidity levels in the atmosphere during this time. It may be necessary to install a drip loop (See Figure 2 on page 72), to prevent moisture from entering the sampling chamber and damaging the ASD unit.

Manufacturing/Industrial

The primary life safety feature of most manufacturing/industrial occupancies is a properly designed, installed, and maintained automatic sprinkler system. However, in many instances the equipment used in the manufacturing process is critical to business operation and requires additional fire protection systems. Fire protection challenges for these areas include:

- Dirty atmospheres where spot-type smoke detectors are not the best option
- Access to spot-type detectors is limited due to high ceilings or obstructions
- Early warning of the presence of smoke is critical to a specific piece of equipment
- Smoke detection system to initiate a fire suppression or extinguishing system when a reliable and sensitive detection system is necessary
- Chemical environments that may be corrosive to electronics

Environments Containing Combustible Dust

Traditional spot detectors may not be practical for manufacturing and industrial plants, due to the significant amounts of dust in the atmosphere. Please note the difference between ordinary dust that makes smoke detection difficult and combustible dust that is hazardous. For ordinary dust, waste recycling centres, in-filters (see Figure 1 on page 71), can be installed to minimise nuisance alarms. However, combustible dust has specific requirements.

NFPA (4) defines combustible dust as “finely divided solid particles that present a dust fire or dust explosion hazard when dispersed and ignited in air.” Examples of manufacturing and industrial facilities where combustible dust is present include:

- Wood processing plants
- Food processing that contains flour, grain or corn
- Coal processing plants and coal fired power plants

Caution should be taken whenever installing an ASD unit in environments that contain combustible dust. These environments are often explosive in nature or have the potential for a dust flash fire; as a result, they may require Intrinsically Safe (IS) devices, and not all ASD units are listed or approved for these atmospheres. Refer to the manufacturer’s listings and approvals whenever installing ASD units in these environments.

In the US, atmospheres that contain dust are classified by NFPA (5) as either Class II Division 1 or Class II Division 2, and each of these classes has specific requirements for the installation of electrical equipment. For these atmospheres, special precautions are taken to eliminate all potential ignition sources.

Prior to installing an ASD unit and sampling pipe in Class II Division 1 or Class II Division 2 atmospheres, refer to the manufacturer’s recommendations and installation manual.

Environments Containing Hazardous Chemical Vapour

Many manufacturing and industrial processes utilise flammable gases, flammable liquids that produce vapours, or combustible liquids that produce vapours: all of these fuels present a significant challenge for fire protection.

Caution should be taken whenever installing an ASD unit in environments that contain or generate chemical vapours. These environments are often explosive or corrosive in nature and could damage the electronics of the ASD unit. Refer to the manufacturer’s listings and approvals whenever installing ASD units in these types of environments.

The atmosphere may also contain corrosive chemical vapours that could potentially damage either the sampling pipe or the electronic equipment.

In the US, atmospheres that contain these conditions are classified by NFPA (5) as either Class I Division 1 or Class I Division 2; each of these classes has specific requirements for the installation of electrical equipment. For these atmospheres, special precautions are taken to eliminate all potential ignition sources.

Prior to installing an ASD unit and sampling pipe in Class I Division 1 or Class I Division 2 atmospheres, refer to the manufacturer’s recommendations and installation manual.

Motor Control Rooms

A Motor Control Centre (MCC), the main control room that houses all the electronic control equipment, is a common place for an ASD system within an industrial plant. A MCC is usually a modular cabinet system for powering and controlling motors, and an MCC room may have a 6 m (20 ft.) ceiling, with air supply and returns mounted at a lower level. Rows of electrical cabinets are typically 2.4 m (8 ft.) tall and cable tray tiers are mounted at 3.6 m - 5.4 m (12 ft. - 18 ft.)

Spot-type smoke detectors have difficulty sensing fires in MCC rooms because of their airflow patterns, which can heavily dilute smoke and prevent it from reaching the detectors. Also, because electrical cabinets generally have gaskets on their doors with no vents, fire can potentially develop for a long time inside the cabinet (see Figure 5 below), before enough heat and smoke escape to trigger an alarm in a standard detector. Heat build-up in these high-ceilinged rooms could also stop the cooler smoke from rising to the ceiling and triggering an alarm. If these MCCs

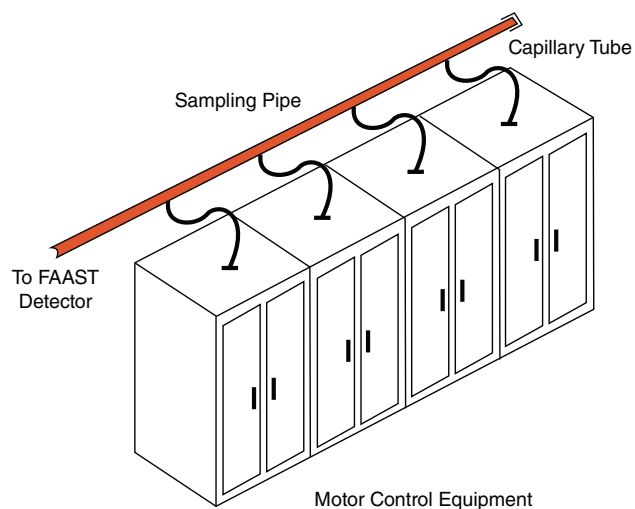

Figure 5. Sampling motor control units utilising capillary sampling points

are critical for production, then fire damage to electrical cabinets could negatively impact.

Cabinets should have sufficient leakage when providing air sampling within a closed cabinet, in order to allow minimal air movement for the sample point and avoid a vacuum situation inside the cabinet.

ASD systems provide various sensitivity levels that can detect very small quantities of smoke, mitigating the effects of dilution and enabling a response before costly damage or loss can occur. ASD units provide fully programmable alarm levels, so strategic responses can be customised to specific smoke thresholds for the facility.

When installing capillary sampling points, ensure all tubing has the same size and length. The tube length should not exceed 8 m (26 ft.) and the sampling hole is installed near the top of the cabinet.

Common Issues/Application Troubleshooting

It's not uncommon for the sampling holes and filters to become clogged when installing an ASD system in dusty or dirty environments. It is critical to regularly clean the ASD sampling holes and pipe, to keep the system operating at the optimal level.

It may be necessary to install an additional filtration system on the sampling pipe before the air reaches the ASD unit. Additional purging of the sampling pipe may also be necessary to keep sampling holes clear of obstructions. A corresponding maintenance regime should be implemented to minimise dust accumulation in the sampling pipe and the sampling holes, as well as to minimise clogs in the ASD unit filter.

ASD units are shipped with factory default sensitivity levels, which may not be appropriate for applications where dirt and small traces of smoke particulates are present in the air. If the default alarm sensitivity thresholds are maintained, the ASD unit will not provide the optimal detection and could potentially transmit nuisance alarms, making the system unreliable. For these environments, it is important to utilise the auto-learn feature or a reference detector if necessary.

Dos

- Identify applicable codes and insurer's requirements
- Replace the filter often to avoid clogging
- Install an in-line filter if larger particles need to be removed from the sampled air
- Purge sampling pipe network regularly to ensure sampling holes and pipes are clear of obstructions
- Use the auto-learn feature to determine obscuration levels and alarm threshold settings
- Clean sampling holes regularly to keep clean
- If condensation is a possibility, install a drip loop

- Ensure all sampling pipe connections are tight

Don'ts

- Install the ASD unit in a location that has the potential of being hit by machinery or operating equipment
- Install the ASD unit in an area that is frequently washed down
- Install ASD units in Class I or Class II environments if the unit is not UL-listed for these classes of environment

References

1. Dungan, K., Storage and Handling of Solid Fuels, NFPA Fire Protection Handbook, Volume 1, 20th Edition, Section 7, Chapter 1, page 7-13, National Fire Protection Association, 2008
2. NFPA 82: Standard for Incinerators and Waste and Linen Handling Systems and Equipment, (Section 8.2), 2014 edition, National Fire Protection Association
3. NFPA 150: Standard on Fire and Life Safety in Animal Housing Facilities (Sections 6.2.1.1, 6.2.1.2, and 6.2.1.3), 2013 edition, National Fire Protection Association
4. NFPA 499: Recommended Practice for the Classification of Combustible Dusts and of Hazardous (Classified) Locations for Electrical Installations in Chemical Process Areas, 2013 Edition, National Fire Protection Association
5. NFPA 70: National Electrical Code (Article 500), 2014 Edition, National Fire Protection Association

Transportation Facilities

Application Overview

Transportation facilities are environments in which a lot of people, baggage, or goods move through complex structures located both above ground and underground. Public transportation hubs may include train stations, city rapid transit stations (i.e., metro, buses and tramway), airport terminals, and ferry slips and taxi stands. Modern hubs allow multiple direct connections between the airport transportation mode and other modes, such as car (parking lots), train, or metro. Public transport centres (also called transit centres) have for years served to connect train stations and bus transportation depots. For example, South Station (see Figure 1 below), in Boston, Massachusetts constitutes a major transportation hub, with railway, bus, and metro services. It should be noted that in Figure 1 (besides the transportation of people), a transportation hub usually contains waiting areas where people can eat or shop in leased areas, located in large open spaces or concourses.



Figure 1. Boston South Station

(Source: <http://en.wikipedia.org/wiki/File:SouthStationInterior.jpg> and <http://www.south-station.net/PDF/South%20Station%20Directory%20-%20Portrait%20-%202013-01-23.pdf>)



Figure 2. Subway transportation hub

Public transportation hubs vary in size and importance, and parts of a hub could be underground or above ground level. A hub can connect several terminals with different modes of transportation, which are managed by different entities. Within a subway transportation system, a station connecting several lines could be considered a hub. People walk from the station entrance to the train platforms, but the trains and tunnels pose risks to the people in or near these locations (see Figure 2 above).

A transportation hub requires energy and power facilities to support the equipment operations and maintain comfortable environments for the public. Areas that house utilities, air handling systems, or emergency systems (often called "ancillary areas"), may need to be protected against fire threats because they can be essential to the transportation hub's operations.

Behind-the-scenes air traffic control operations are also critical for airports because they continuously move planes and passengers to destinations around the World. For example, the London Terminal Control Centre manages air traffic for five London area airports: a small fire event in such a facility can result in staff evacuation and the large-scale disruption of hundreds of inbound and outbound flights. Hours or days of rescheduled flights may then be needed to get passengers to their planned destinations.

Many rail systems are managed through Operations Control Centres (OCC) (see Figure 3 below), using a Supervisory Control And Data Acquisition (SCADA) system, which enables the remote control and monitoring of field equipment located in the stations and power sub-stations. Other important SCADA system functionality includes the "control of traction power, control of emergency ventilation systems, and monitoring of drainage pumps and various equipment alarms, including intrusion monitoring of remote



Figure 3. The metro subway control room inside the Maryland Transit Administration (MTA) Control center (4)

locations (1, 2)." The SCADA infrastructure may be integrated with a data centre, processing real-time information reported from the entire transportation network. Due to its extreme importance on operational continuity, the OCC is provided with battery power supplies and/or generator rooms in the case of network electrical power loss.

Fires can directly impact transportation facilities' operations. In a few cases there have been serious life safety consequences, but rail or air service disruptions and inconvenienced passengers are far more common. A few examples follow:

- The 1987 King's Cross Metro station (London, UK) fire started under a wood escalator and rapidly engulfed most of the station with smoke that resulted in 31 fatalities and numerous injuries. The fire exposed the paths of egress from train platforms to outside of the subway station, leading to a rapid smoke spread via all the vertical and narrow spaces, such as escalators and elevator shafts
- A 2009 electrical fire in the air traffic control tower at the Prague Airport caused it to cease operations and suspend or divert flights for several hours. No occupants were injured and no essential equipment was damaged, but the fire created so much smoke that the tower had to be closed. Arrivals were sent to other airports and departures were delayed, since all flights in and out of Prague Airport were suspended
- 20th June, 2010: a fire in Chicago's subway system left at least 12 people with smoke-related injuries and five of them in a serious condition. Railroad ties in a tunnel near an underground station caught fire after apparently being ignited by sparks from passing trains (4)

- June 2011: Take-offs and landings were suspended at the Dallas Love Field after a small fire broke out on the fifth level of the FAA Air Traffic Control Tower one afternoon. Air traffic controllers evacuated the tower for more than a half hour, resulting in a number of diverted flights
- 14th August, 2012: an apparent tunnel cable fire in New York City (5) affected six of the lines that connect Brooklyn to Manhattan, as the tunnel was close to a hub station in Brooklyn
- 13th February, 2013: an engine burned out on a Philadelphia subway train, causing it to fill with smoke. The fire was placed under control in about 15 minutes, causing no injuries (6)
- 5th June, 2013: a power cable caught fire in a tunnel near one Moscow metro station, forcing the evacuation of thousands of rush hour commuters. Fifty-nine people required medical attention and eleven were hospitalised (7)
- 28th November, 2013: heavy amounts of water may have caused cables to short out between two subway stations in Brooklyn, New York, disrupting the service of three subway lines for six hours but injuring no one (8)
- 13th May, 2014: an electrical fire triggered by a bathroom exhaust fan forced the evacuation of an air traffic control facility near Chicago, halting all flights at the city's two airports and shutting down one of the nation's busiest airspaces. The evacuation of the smoky air-traffic control facility, combined with thunderstorms, resulted in the disruption of nearly half the flights at O'Hare airport and nearly one-third at Midway airport.

- An ability to be used around potential fire sources like high voltage cables, switch gear, and power supply batteries. Early detection is essential for these valuable, substation pieces of equipment
- An ability to actively sample air in large open spaces, such as in atria and concourses, where smoke stratification can occur (since smoke generated from small fires would not have enough buoyancy to reach the ceiling of such spaces)
- An ability to differentiate smoke particulates from dust, reducing false alarms while monitoring dusty service ducts and tunnels
- An ability to detect fires in concealed spaces and any other areas where testing and maintenance could be difficult for access

Design Best Practices

Aspirating smoke detection can play an important role in transportation facilities' fire protection strategies by accommodating diverse structures both above ground and underground. Some of the main transportation applications for aspirating smoke detection include:

Airport Terminals and Concourses: The large multi-level spaces and concourse areas of airports provide the circulation space needed for large populations to flow between ticketing areas and boarding gate areas. Retail facilities, restaurants, and business lounges are commonly provided to service passengers before and after their travels. Due to the large populations and multi-level configurations found in airports, smoke management systems and air handling systems are often provided

Benefits of Aspirating Smoke Detection

The presence of escalators, elevator shafts, vertical stairs combined with train tunnels, interconnected corridors, and constantly opening and closing doors creates alternating local drafts and turbulent air flows within transportation facilities. Large open spaces such as atria and concourses also complicate smoke detection, and smoke dilution and stratification may challenge the capabilities of point smoke detectors. The installation flexibility of vertical ASD pipes, combined with their very low thresholds, overcomes smoke dilution and stratification challenges.

In-duct smoke detection may be required in the numerous service ducts of an airport or rail station, as well as in other conduits or ventilation shafts. Point smoke detectors may be difficult to install and maintain in these locations, especially for large open spaces, but ASD sampling pipes provide more effective protection.

Aspirating smoke detection (ASD) has many benefits for transportation facilities, including:

- Low threshold values, which can help detect fires during the incipient fire stage, even if smoke levels are quite low. This early fire detection increases the time for safe evacuation as well as for fire suppression actions, which can reduce property loss and business interruption
- An ability to actively sample air in non-quiet environments, such as in air movements created by trains going through tunnels, in elevator shafts, and in data centres
- An ability to actively sample the inside of electronic cabinets which are essential to the control, notably the cabinets used in transportation hub control rooms



Figure 4. – Airport ticketing concourse and Escalator pedestrian circulation zone.



Figure 5. – Airport shopping concourse and high ceiling space.

to prevent smoke recirculation and/or exhaust smoke in the event of a significant fire. Aspirating smoke detection is well suited to provide effective smoke detection in the high-ceiling spaces and complex ceiling configurations that may be encountered. The smoke movement systems are intended to provide adequate time for a safe evacuation of occupants through the airport atrium and concourse spaces. However, a false alarm that initiates evacuation alarms can be highly disruptive in an airport environment (flight delays). Aspirating smoke detection offers stability against false alarms and can provide pre-alerts needed for airport staff to investigate developing situations prior to the need for an evacuation.

Air Traffic Control Facilities: Efficient and uninterrupted airport operations depend on air traffic control services that track and direct aircrafts on the ground and in airspace. The electronic systems, radar systems, communication links, and power supplies are critical to maintaining air and ground safety, as well as to expediting the flow of aircraft and passengers. Air Traffic control Towers (ATCTs), and terminal radar approach control facilities (TRACON), require a high standard of fire protection to assure continuous and uninterrupted operations. Automatic smoke detection and alarm systems are very important for these facilities. Smoke detectors, including aspirating smoke detection, should be considered for locations near all probable sources of fire or smoke, including mechanical equipment rooms, return air plenums, electrical/electronic rooms, facility operational areas, etc. Aspirating smoke detection is crucial in electronic rooms to provide the earliest warning of incipient conditions.

Train/Subway Facilities: NFPA 130, Standard for Fixed Guide-way and Transit Systems, is recognised around the World for its guidance on station and rail tunnel fire safety design. The train-way typically serves as the means of egress for passengers in the event of train evacuation. In an enclosed train way/ tunnel, enclosed exits and cross-passageways serve as a point of safety and a means of egress. NFPA 130 requires an enclosed or tunnel train-way 61 m (200 ft.) or more in length with emergency ventilation to maintain a tenable environment along the path of egress from a fire incident. Modern transit station design consists of a large space formed by the passenger platform and contiguous train way, possible intermediate mezzanine level(s), and several continuous connections to the street level above. Modern stations often include extensive use of escalators and elevators for efficient passenger movement. NFPA 130 requires the installation of emergency ventilation in enclosed stations to maintain tenable conditions during passenger evacuation. The basis of station platform design is the NFPA 130 requirement: to evacuate all passengers from the platform in four minutes, and to reach a point of safety within six minutes.

There is significant emphasis on emergency ventilation systems under the provisions of NFPA 130, and accordingly there must be appropriate means to detect smoke and initiate fans and equipment for emergency ventilation. Aspirating smoke detection provides this capability and can operate in the dirty/dusty airflow conditions found in train ways and enclosed stations.

NFPA 130 also specifies fire detection functions for key operational areas of rail system facilities, which can be well served by aspirating detection systems:

- Traction power sub-stations and signal bungalows require heat and smoke detectors to be installed and connected to the operations control centre (OCC)
- The OCC, is to "be protected by fire detection, protection, and extinguishing equipment so that there will be early detection and extinguishment of any fire in the OCC". In addition, fan units serving train control and communications rooms should be protected by fire detection, protection, and extinguishing equipment so that there will be early detection and extinguishment of any fire involving these units.



Figure 6 – Train platform and train way

Critical Utility / Equipment Areas: Power systems, pumping stations (in tunnels), air traffic control towers, SCADA control systems, and other critical equipment and utility areas are key to the operations of transportation facilities. Given the risk of loss of transportation facility operations due to a fire in utility and critical equipment areas, it's important to identify even the smallest fire events, such as precursor smouldering or equipment overheating. Aspirating smoke detection can provide the high sensitivity and continuous sampling of low quantities of smoke that may be needed to identify and avert downtime. Some aspirating smoke detectors can also withstand dirty/dusty environments found in tunnels, some utility equipment rooms, and baggage handling equipment areas, while providing effective early detection without concern for false alarms and process or equipment shut-down.

High voltage substations, data centres, and OCCs contain electric cabinets and electronic cabinets incorporating fire loads. Sampling each cabinet's internal atmosphere via capillary tubes allows active and quick smoke detection in the early fire stages (see Figure 7 below). This is particularly important for assuring the operation and business continuity of transportation hubs, since any malfunction of the electronic cabinets may cause a disruption in the management of this complex system.

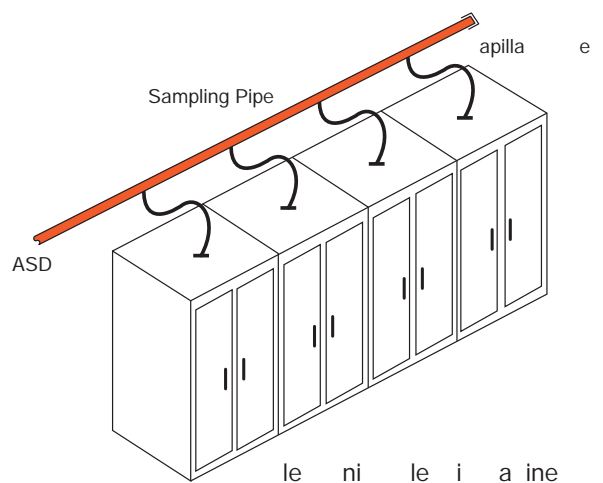

Figure 7. Sampling electronic/electrical cabinets utilising capillary sampling points

The intensive use of electric power generates heat in these areas, requiring an air conditioning system to cool the heat-sensitive equipment and ensure it doesn't malfunction. Installing additional sampling pipes in the air conditioning system's return air vent would also allow smoke detection..

Tunnels and Ducts: Service ducts and tunnels are potential fire locations in the underground part of a transportation hub. With an ASD system, pipe can be positioned in the ducts and the ASD unit placed in a service room for easy access. This configuration offers low maintenance and testing costs, and the ASD system's advanced electronics and filter decreases false alarms and differentiates between fire smoke particulates and the dust particles in service ducts and tunnels.

Common Issues/Application Troubleshooting

Coordination and interfaces with an automatic fire suppression system and emergency protocols

It is important to coordinate the smoke detection system with the fire suppression system. Carefully consider design practices to determine when the system should activate the fire suppression system. It is recommended to review the discharging of a fire suppression system with the local Authority Having Jurisdiction (AHJ). This also applies to the fire alarm panel, to determine when an alarm signal should be sent to a central monitoring station and when the emergency protocols should be activated to start emergency evacuation. Such precautions allow evacuation in the safest conditions possible, especially for passenger cars.

Aspirating smoke detection's (ASD) remote detector programmability and other benefits make it suitable for a transportation and logistics hub configuration. However, consider the following factors when using an ASD within this type of configuration:

- The sensitivity levels and alarm thresholds should be as low as possible, in order to detect the smallest production of smoke and to allow fire investigation
- The designer needs to verify the airflow and direction of air within the space to maximise the system's effectiveness. The sampling points should be installed in the direction of the airflow, especially in the air return ducts. The sampling response time can be improved by avoiding high and low velocity air flows perpendicular to the sampling holes. Sampling holes on the inlet pipes installed in ducts, return air grills, or air conditioning unit ducts (where high velocity air will be passing over the sampling pipe), should be facing 20°-45° from the air flow (see Figure 8 below)

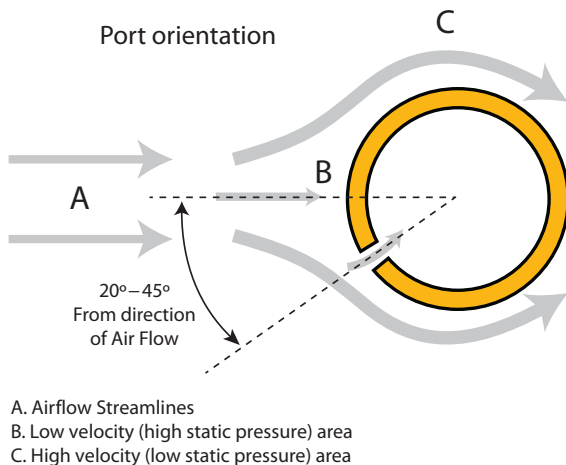

Figure 8. Sampling hole orientation for pipes installed in ducts, return air grills, or on air conditioning unit ducts with high velocity circulating air

- For large detection systems with many sampling holes, the designer needs to take smoke/air dilution into consideration. A greater volume of air returns to the aspirating detector the more sampling holes the air sampling pipe contains, and this can dilute the quantity of smoke within the detection chamber and delay the alarm initiation time
- The location of the sampling holes within the detection network is a concern. The further the sampling hole is located from the aspirating smoke detector, the more air/smoke dilution occurs, which could delay the alarm initiation time. It should be noted that the system design must comply with the restrictions of the detector. In other terms, the ASD system must not exceed the pipe and sample hole maximum requirements for the lowest thresholds of smoke the system is planned to detect.
- Special care will be given to the design of air sampling pipes, sampling hole locations, and spacing for large open space and duct applications.

Programming consideration of the aspirating smoke detector during commissioning process

During the commissioning process, the installing contractor needs to properly program the alarm thresholds and sensitivity levels. These programmable sensitivity levels and alarm thresholds could significantly impact the performance of the aspirating smoke detector. Consider the following in regard to programming:

- Typically aspirating smoke detectors are shipped with default settings from the factory. These settings are not appropriate for all detection systems. These settings are to be considered generic and may be too sensitive or not sensitive enough for a specific application. The ASD designer must determine the alarm levels and program the sensor accordingly. The sensitivity levels and alarm thresholds are determined by a combination of the computer-based calculation program, the hazard being protected, detection system size, and engineering judgment
- Programmable sensitivity levels are another significant issue impacting the performance of aspirating smoke detection systems. The detectors contain sophisticated electronics and software that allow the device to be programmed to a wide range of sensitivity levels. However, if these alarm levels are not programmed properly, then the smoke within the sensing chamber may exceed the desired sensitivity and cause a delay in the alarm signal initiation
- When required in Europe and the US, the ASD unit programming must also comply with the sensitivity levels prescribed by the EN-54 and NFPA standards, respectively

Time delays for initiating further actions

Time delays are also included for the activation of trouble and alarm signals at the detector. These delays can be set for a range of times, typically from 10 - 30 seconds. Give careful consideration when programming the time delays; the greater the delay, the longer it takes for the detector to initiate an alarm signal.

Dos

- Identify applicable codes and insurer's requirements
- Refer to the appropriate sections of ASD application guides for:
 - Large and open spaces (for ASD sampling of atria and concourses)
 - Data centres
 - In-cabinets (in the "Principle" guide)
 - Harsh environments (for ASD sampling of dusty tunnels)
 - In-duct (for ASD sampling of HVAC ducts)
- Identify and understand any smoke control and/or pressurisation schemes that need to be implemented upon smoke detection. Important smoke control functions can be properly initiated, when using associated outputs of aspiration smoke detectors
- Provide protection against smoke-contaminated air flows by installing air sampling points for makeup air units, air handling units, and key air return points (air grills or dry coil returns to ducts or plenums). For air returns, arrange the sampling ports so that each covers no more than 0.4 m² (4 ft²) of the return opening
- Identify critical or high-risk equipment installations that should have localised area or in-cabinet air sampling for earliest warning and initiation of human response
- Confirm and implement how the alert settings and fire alarm settings of aspirating systems are to be integrated to initiate the following if applicable: 1) power shut-down, 2) fixed fire suppression systems, 3) air handling shut-down and associated damper or door closures, 4) smoke control and room pressurisation operations
- When NFPA 130, Standard for the Protection of Semiconductor Fabrication Facilities, applies, the following is recommended
 - Consider aspirating smoke detection for traction power sub-stations, signal bungalows, and the OCC
 - Transmit alarms from aspirating smoke detection to a constantly supervised location
- When EN 54-20 (Fire detection and Fire Alarm Systems – Part 20: Aspirating Smoke Detectors), applies, the following is recommended:
 - Review the environment to identify the nature of the air flows and criticality of equipment or processes to be protected. This will help identify the sensitivity Class of the aspirating system that needs to be installed in any given area
 - Identify where Class C, aspirating type smoke detection is to be applied
 - Identify where Class B, aspirating type smoke detection is to be applied. Class B systems are used when increased sensitivity is needed to compensate for moderate dilution effects due to high ceilings or moving air flows. Also, for protection of vulnerable and critical items
 - Identify where Class A, aspirating type smoke detection is to be applied. Class A systems are used in areas having very high air movement and high dilution and the very earliest warning is needed to protect highly critical business operations

References

1. American Public Transportation Association (APTA), Recommend Practice, Securing Control and Communications Systems in Transit Environments, Part 1: Elements, Organisation and Risk Assessment/Management (APTA SS-CCS-RP-001-10), July 2010
2. http://www.arinc.com/sectors/transportation/rail/control_systems/scada.html
3. <https://technical.ly/baltimore/2013/03/22/reinvent-transit-hackathon-transportation/>
4. <http://www.cnn.com/2010/US/06/20/chicago.subway.fire/index.html>
5. <http://abclocal.go.com/wabc/story?section=resources/traffic&id=8773530>
6. <http://philadelphia.cbslocal.com/2013/02/13/patco-subway-train-catches-fire-in-center-city/>
7. <http://www.cnn.com/2013/06/05/world/europe/moscow-subway-fire/index.html>
8. <http://www.nydailynews.com/new-york/brooklyn/subway-fire-disrupts-brooklyn-bound-trains-article-1.1532340>
9. NFPA 130: Fixed Guide-way Transit and passenger Rail Systems, 2014 Edition, National Fire Protection Association

Historic and Cultural Buildings

Application Overview

Historic buildings and buildings that house cultural resources require careful approaches to fire protection, due to the unique risks and circumstances they pose. Such buildings include historically registered landmarks, religious buildings, museums, libraries, and art galleries, as well as any building or structure presenting a unique or iconic design and aesthetics. Others contain invaluable artefacts or heritage assets. Some historical buildings were built using archaic construction techniques and with materials that may no longer be available. Buildings can not only be historic in nature and difficult to re-create if damaged, but their contents can also be even more valuable and irreplaceable. Heritage and cultural collections include priceless artwork, documents, and books that are culturally and/or historically significant. Therefore, the fire safety measures applied in historic and cultural facilities need to provide a satisfactory level of fire protection and pose little or no harm to the historical fabric or valuable contents of the building.



Minnesota History Center

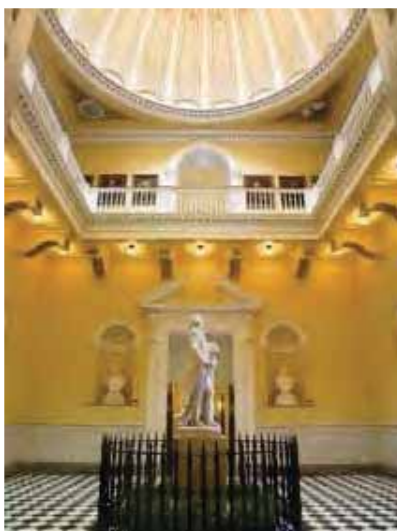

State of Virginia – Capitol Rotunda

Figure 1. Examples of historical buildings

Aspirating smoke detection offers solutions for historic/cultural environments to achieve a proper balance. Historic and cultural buildings are often public venues with significant crowds, and facilities like food service and child care areas are needed to accommodate the visiting public. Life safety risks should also be addressed in these applications.

Fires involving historical structures and cultural facilities can be very costly, not only in terms of damage to the structure and building contents (artefacts) but also because of the loss of business operations. Consider the Louvre in Paris and the British Museum in London, which draw approximately 9 million and 6 million visitors each year, respectively. A major fire in either of these two museums would generate significant revenue losses.

Back-of-house or non public areas may often present significant fire loads or unusual fire risks, such as store rooms in museums and conservation/preservation laboratories that use flammable liquids or other chemicals. Museums and libraries use a large amount of plastic-based storage containers, including film storage, magazine dividers, storage boxes and bins, clothing bags, and various covers. Smoke produced by the combustion of these plastic materials may be thick and acrid, which can damage the museum and library collections in the area of fire origin and throughout the connected facility. It should be noted that the electrostatic characteristics of these plastic covers and bags have a tendency to attract smoke particles to clothing and other fabrics.



Figure 2. and Figure 3 New York State Museum Storage Room (cardboard boxes) and Carnegie Museum of Natural History ("Big bone" collection storage room with wood boxes)

From a fire protection perspective, book stacks and stored collections are often more comparable to warehouses than typical business occupancies. Figure 4 on the following page, presents a basic depiction of the fire environment that may develop within a historic/cultural structure. The fire releases heat, light, and other products of combustion. The possible negative consequences directly attributable to the fire are as follows:

- Human injury or fatalities
- Reduced visibility or blocked passages of building spaces
- Fire and smoke damage or destruction of building contents
- Fire and smoke damage or destruction of the building structure
- Interruption of operations
- Financial Loss

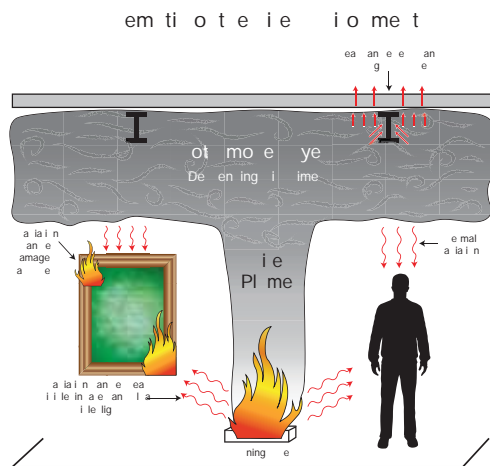

Figure 4 .- Fire Environment in a Heritage Environment

Indirect consequences of a fire can also affect historic/cultural buildings and increase the need for a prompt response. The following indirect consequences are a special concern for the historic fabric and contents:

- Water damage
- Physical damage due to fire suppression efforts with hose streams
- Damage due to mishandling or moving of objects in emergency fire conditions
- Damage due to a cleaning or restoration process after a fire
- Threat of theft during fire

Benefits of Aspirating Smoke Detection

Aspirating smoke detection (ASD) has many benefits for historic buildings, including:

- Low threshold alert and alarm values, which can help detect fires even if smoke levels are quite low during the incipient fire stage. This early fire detection increases the time for safe evacuation, allows for fire suppression actions to reduce potential damage, and reduces the risk of business interruption
- Active air sampling in large open spaces such as in atria, concourses, and high ceiling spaces where smoke stratification is possible (smoke generated from small fires may not have enough buoyancy to reach the ceiling of such spaces)
- Fire detection in concealed spaces and any other areas where testing and maintenance could be difficult
- An ability to be integrated in the historic structure and fabrics with minimal alteration, visual or otherwise
- An ability to include different levels of warnings and alarms to provide an opportunity for building occupants to investigate and manually use fire suppressants, before an automatic fire suppression system starts to operate
- The possibility to sample in-duct for high airflow and atmospheres that contain controlled HVAC configurations

Design Best Practices

The long list of fire risks associated with historic and cultural resource buildings is addressed with several key documents, which outline guidance and approaches for developing appropriate fire protection in such buildings. Since the 1940's, the US-based National Fire Protection Association has fostered an interest in historic buildings and contents. The NFPA's Technical Committee on Cultural Resources maintains two standards documents specific to the fire risks and concerns for preservation in historic and cultural buildings:

- NFPA 909 "Code for the Protection of Cultural Resource Properties – Museums, Libraries and Places of Worship"
- NFPA 914 "Code for Fire Protection of Historic Structures"

In recent years, efforts have been made in British, European, and ISO standards development, for comparable NFPA documents, including:

- BS 7913: 2013 "Guide to the Conservation of Historic Buildings"
- Scotland Technical Advice Note 28 (TAN 28) – "Fire Safety Management in Heritage Buildings"

These documents contain concepts and considerations to select and implement automatic fire detection in historic buildings. They not only include early fire detection goals, but also the goals to minimise/avoid damage or irreversible changes to the historic fabric.

NFPA 909 "Code for the Protection of Cultural Resource Properties – Museums, Libraries and Places of Worship", adopts such goals and objectives related to:

- Collection preservation: associated with a reasonable level of protection for the stored collections against fire, products of combustion, fire suppression agents and activities
- Building preservation: associated with a reasonable level of protection for unique characteristics and fabric of these buildings against fire, products of combustion, fire suppression agents and activities
- Continuity of operations: associated with a reasonable level of protection against "disruption of facility operations consistent with the organisation's mission and protection goals".

Cultural buildings may also be classified as historic structures; in such cases, additional fire protection goals and objectives may be also considered. NFPA 914, "Fire Protection of Historic Structures", adds to the life safety goals and historic preservation goals as follows:

- To minimise the damage to historic structures and contents from fire events, including the effects of the fires and the fire suppression actions
- To maintain and preserve the original space configuration of the historic building
- Minimising alterations, destruction, or loss of historic material or design

In other countries such as Scotland, TAN 28 provides a philosophy and considerations for heritage buildings similar to and consistent with those outlined by NFPA.

Integration in the historic/cultural environments

The use of conventional ceiling-mounted fire detection devices is often considered adverse to the historic fabric or desired aesthetic design of a cultural space. Aspirating smoke detection will minimise, if not almost eliminate, this intrusion into a space. ASD systems use sampling holes of limited size that draw air into the system, where they're sampled for smoke particulates in an ASD unit remotely located in a separate room or closet. The sampling holes can be installed flush with ceilings or placed in ornate or articulated ceilings where the ceiling features act as camouflage. In addition, the sampling pipe network and capillary tubes can extend from the pipes concealed behind ceilings, walls, or installed in void spaces.

Capillary tubes are flexible; for example, they can follow the curves of a supporting chain of a monumental chandelier (see Figure 5 below) or be installed in the crown moulding at the ceiling level. In many instances, the sampling holes are small and cannot be seen from the floor level.

Airflow in large open spaces and ducts

Many culturally significant buildings contain valuable artwork, which means temperature and humidity are regulated by systems that affect the space's airflow. These systems often contain high-quality filters to remove airborne dust and particulates that may degrade valuable artwork, which also requires regulated HVAC systems. For buildings with highly regulated HVAC systems, it is possible to use in-duct ASD units.

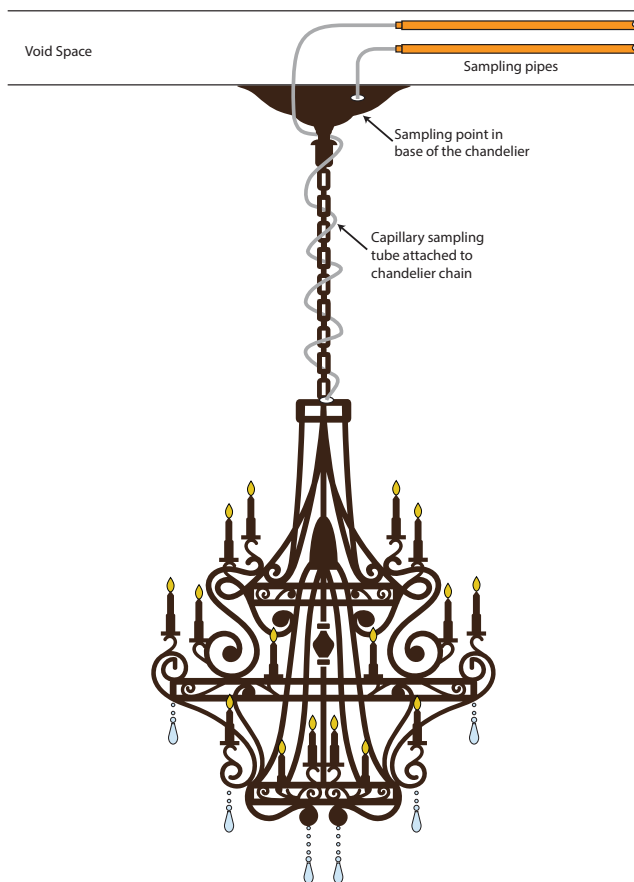

Figure 5. Capillary sampling tube installed in the supporting chain or the base of a chandelier

Historic buildings may contain large open spaces such as churches, atria, museum concourses, and large open stairwells, where phenomena such as smoke dilution and smoke stratification may be a challenge for traditional smoke detectors. Vertical ASD pipes' installation flexibility and their low thresholds and sensitivities, can overcome smoke dilution and stratification challenges.

As indicated above, ASD sampling hole locations of interest would be:

- Installed in the ceiling, since the sampling holes are small in diameter the holes are often overlooked or cannot be seen from the floor level
- Capillary tubes and sampling holes can be installed in crown moulding and can be incorporated into intricate and ornate ceilings
- For large ballrooms and open areas, capillary sampling tubes can be installed along the chain of a chandelier, or a small hole can be drilled in the base of the chandelier to conceal a sampling point
- In return and supply air distribution systems

Construction differences - historic versus modern buildings

Due to their period of construction and their historical character, it's often difficult to retrofit old buildings with fire protection measures required by modern building codes. The Common construction issues include:

- A historic staircase, with all rooms opening directly to the staircase (preventing the use of fire compartments, such as self-closing fire doors)
- Building does not contain a suitable fire suppression system due to the appearance of sprinklers, nozzles, hose valves, or fire extinguisher cabinets

In such cases, automatic fire detection is important so that a fire can be detected in its incipient stage (before it produces flames), and maintains the historical fabric and without impacting the aesthetics of the building. Aspirating smoke detection is also important for initiating a staff response and/or occupant evacuation in many unique historic scenarios.

Critical detection needs for areas without automatic sprinkler protection

Automatic fire sprinkler systems are a valuable protection feature for many historic and cultural buildings. The piping, fittings, and space needed for routing and concealing sprinkler systems, however, can make it difficult to install such systems without subjecting the historic fabric to undue damage. In cultural resource properties the curators may be averse to allowing sprinkler systems in areas housing water-sensitive collections. In these circumstances, the need for prompt fire detection can be met using aspirating smoke detection. Aspirating smoke detection systems can provide the high sensitivity and continuous sampling of low quantities of smoke that may be slowly distributed and easily diluted by the airflow environment.

For European-based properties, EN 54-20 can be helpful in the decision-making process for determining the desired detection sensitivity for various areas of historic/cultural buildings. EN 54-20 specifies a classification system for aspirating detection according to Class A, B, and C categories, as noted in Table 1 on the following page. Depending on the room or space and other attributes (ceiling height, historic value of contents, airflow environment, etc.), Class A, B, or C type aspirating systems may be appropriate. Certainly, those facilities with high ceilings and important

collections would favour EN 54-20 Class A or B systems when aspirating technology is being installed.

Table 1 - Classification of Aspirating Smoke Detection Systems According to EN 54-20		
	Sensitivity	Area of Application
Class A	Very high	Very early warning fire detection, building areas with high levels of air movement /air changes
Class B	Enhanced/High	Very early warning fire detection , building areas housing valuable goods and/or processes that need early detection
Class C	Normal/standard	Application for general fire protection, similar to standard point or spot detector applications

Common Issues/Application Troubleshooting

Aspirating smoke detection's (ASD), remote detector programmability and other benefits make it suitable for historical buildings or structures. However, during the design phase, consider the following factors when using an ASD within this type of configuration:

- The sensitivity levels and alarm thresholds should be as low as possible in order to detect the smallest production of smoke, to allow fire investigation
- The designer may need to verify the airflow and direction of air within the space to maximise the system's effectiveness
- For a large detection system with many sampling holes, the designer needs to take smoke/air dilution into consideration. A greater volume of air returns to the aspirating detector the more sampling holes the air sampling pipe contains, which can dilute the quantity of smoke within the detection chamber delay the alarm initiation time
- The location of the sampling holes within the detection network is a concern. The further the sampling hole is located from the aspirating smoke detector, the more air/smoke dilution occurs, which could delay the alarm initiation time
- Special care will be given to the design of air sampling pipes, sampling hole locations, and spacing for large open space and duct applications

Programming consideration of the aspirating smoke detector during commissioning process

The installing contractor needs to properly program the alarm thresholds and sensitivity levels during the commissioning process. These programmable sensitivity levels and alarm thresholds could significantly impact the performance of the aspirating smoke detector. Consider the following in regard to programming:

- Typically aspirating smoke detectors are shipped with default settings from the factory. These settings are not appropriate for all detection systems. These settings are to be considered generic and may be too sensitive or not sensitive enough for a specific application. The ASD designer must determine the alarm levels and program the sensor accordingly

The sensitivity levels and alarm thresholds are determined by a combination of the computer-based calculation program, the hazard being protected, detection system size, and engineering judgment

- Programmable sensitivity levels are another significant issue impacting the performance of aspirating smoke detection systems. The detectors contain sophisticated electronics and software that allow the device to be programmed to a wide range of sensitivity levels. However, if these alarm levels are not programmed properly, then the smoke within the sensing chamber may exceed the desired sensitivity and cause a delay in the alarm signal initiation

Time delays for initiating further actions

Time delays are also included for the activation of trouble and alarm signals at the detector. These delays can be set for a range of times, typically from 10 - 30 seconds. Give careful consideration when programming the time delays; the greater the delay, the longer it takes for the detector to initiate an alarm signal.

Dos

- Identify applicable heritage codes and guidance, including related assessments, requirements, and performance criteria specified for fire detection systems. BS 7913: 2013, TAN 28 (Scotland), NFPA 909, NFPA 914 or others may be applicable.
- Refer to the appropriate sections of ASD application guides for: Large and open spaces (for ASD sampling of atria and high ceiling areas)
- In-duct monitoring (for ASD sampling of HVAC ducts)
- Identify critical historic spaces or high-risk collections that should have earliest warning and initiation of human response
- Confirm and implement how the alert settings and fire alarm settings of aspirating systems are to be integrated to initiate the following if applicable: 1) power shut-down, 2) fixed fire suppression systems , 3) air handling shut-down and associated damper or door closures, 4) smoke control and room pressurisation operations, 5) evacuation alarms

When EN 54-20 (Fire Detection and Fire Alarm Systems – Part 20: Aspirating Smoke Detectors), applies the following is recommended

- Review the heritage environment to identify the nature of the airflows and criticality of contents to be protected. This will help identify the sensitivity Class of air the aspirating system that needs to be installed in any given area
- Identify where Class C, aspirating type smoke detection is to be applied
- Identify where Class B, aspirating type smoke detection is to be applied. Class B systems are used when increased sensitivity is needed to compensate for moderate dilution effects due to high ceilings or moving airflows. Also, for protection of vulnerable and critical items
- Identify where Class A, aspirating type smoke detection is to be applied. Class A systems are used in areas having very high air movement and high dilution and the very earliest warning is needed to protect highly valuable or sensitive collections

Don'ts

- Don't exceed the recommended detector or sampling point spacing of applicable standards or insurance carrier requirements
- Don't use detectors that are not listed or approved for air velocities and temperatures that will be encountered in the airflow paths of historic cultural facilities
- Don't design the aspirating system to exceed the transport time requirements of installation standards

Glossary of Terms

Additive Effect – Effect occurring when smoke particulates enter multiple sampling holes, causing the overall effective sensitivity of the air sampling system to exceed the sensitivity from a single sampling hole on the system.

Air Traffic Control Tower – Tower facility at airports housing the equipment and personnel that manage and direct aircraft take-offs, landings, and ground traffic.

Aspirating Smoke Detector (ASD) System – Smoke detection system that utilises an aspirator (fan) to actively draw air through a pipe network from a space potentially exposed to fire or smoke back to a smoke sensing device.

Aspirating Smoke Detector (ASD) or Unit – Enclosure or physical housing with an apparatus that consists of various components, including sensor(s) for detection of smoke particles and an integral aspirator (fan), which continuously draws air and aerosols through a sampling device.

Capillary Tube – Extension of the air sampling pipe network that is significantly smaller than the main sampling pipe, typically made of plastic or metal tubing.

Central office – A structure used by telecommunications companies to house equipment needed to direct and process telephone calls and data traffic. Telephone Central Offices (COs) are also known as telephone switching centres, wire centres, or public exchanges.

Cleanroom – A room with a controlled concentration of airborne particles that contains one or more clean zones. A clean zone is an area that meets a specified airborne particulate cleanliness class, per the ISO Standard 14644-1 or US Federal Standard 209E (*Note: 209E cancelled in 2001*).

Cold Aisle Containment Arrangement – Arrangement usually installed in data centres, with a physical separation between the cold air supply and hot air exhaust by enclosing the cold air supply aisle.

Collections – Prehistoric/historic objects, works of art, scientific specimens, religious objects, archival documents, archaeological artefacts, library media, and cultural materials that are assembled, stored, displayed, and maintained for the purpose of preservation, research, study, exhibition, publication, or interpretation.

Cultural Resource Properties – Culturally significant buildings, structures, sites, or portions thereof, that house collections for museums, libraries, and places of worship.

Cumulative Effect – See “additive effect”.

Dilution effect – Effect occurring in the case of smoke being drawn into a single sample hole and then transported through the piping network past other sampling holes that are aspirating clean air (no smoke concentration). When this volume of clean air is mixed with the smoke laden air being transported into the detection chamber the quantity of smoke latent air is then diluted.

Duct Smoke Detector – Smoke detector designed to sense smoke in the air flowing into or through an air duct system.

Early Warning – A signal provided by a system that detects fire in its earliest stages of development to enhance the opportunity for appropriate fire safety actions (e.g., evacuation, manual fire suppression).

Early Warning Fire Detection (EWFD) systems – From NFPA 76: detection system that uses smoke, heat, or flame detectors to detect fires before high heat conditions threaten human life or cause significant damage to telecommunications service.

Electronic Data Processing (EDP) – Equipment that is used for processing, receiving, transmitting, or storing electronic data.

EN 54-20 Classification – An aspirating smoke detector of Class A, B, or C sensitivity determined per the European Standard EN 54-20, which specifies the requirements, test methods, and performance criteria for aspirating smoke detectors used in buildings.

Class A – From European EN 54-20 classification: very high sensitivity, for example the detection of smoke particles in extremely diluted concentrations, such as the detection necessary for a clean room.

Class B – From European EN 54-20 classification: enhanced or high sensitivity. For example the detection of smoke particles at enhanced sensitivity for protection of vulnerable or valuable items, such as areas that contain computers or electronic equipment.

Class C – From European EN 54-20 classification: smoke detection at normal sensitivities, where the detection system is spaced and the detector sensitivity is similar to a traditional spot smoke detectors or beam type smoke detection system.

Extreme Environment – Environment with extreme conditions of temperature, airborne contamination, vapours, fumes, humidity, dust, and dirt.

Historic Building – From NFPA 914: A building that is designated, or deemed eligible for such designation, by a local, regional, or national jurisdiction as having historical, architectural, or cultural significance.

Historic Fabric – From NFPA 914: original (or added) construction materials, features, and finishes of a buildings that existed during a time period or era that is deemed to be architecturally or historically significant, or both.

Historic Structure – From NFPA 914: A building, bridge, lighthouse, monument, pier, vessel, or other construction that is designated or that is deemed eligible for such designation by a local, regional, or national jurisdiction as having historical, architectural, or cultural significance.

Hot Aisle Containment Arrangement – Arrangement usually installed in data centres, for which a physical separation is provided between the cold air and hot air exhaust by enclosing the cold aisle. This is intended to capture all the hot air exhaust and return it to the cooling areas. With containment limited to the hot aisle, the remainder of space outside the hot aisle becomes a room flooded with cold air from the HVAC/CRAC unit.

In-Cabinet Sampling – Method involving the installation of air sampling holes to monitor specific piece(s) of equipment located within a larger open space. The piece of equipment is typically self-contained within a cabinet or a computer rack.

Large Duct – Duct with a width greater than 0.9 m (3 ft.) and less than 2 m (7 ft.).

Localised Sampling – Method involving the protection of specific equipment/area within a larger open space. Localised sampling may be a rack sampling system in a large open warehouse or monitoring the exhaust of a row of computer cabinets.

Maintenance Test Point – Point installed at the end of a piping network specifically used to test the ASD system.

Maximum Transport Time – Maximum allowable time it takes the smoke particulate to travel from the most remote sampling hole to the ASD sampling chamber.

NEBS – The Network Equipment Building Standards or NEBS (as defined by Telcordia) are the most widely known and used set of safety, spatial, and environmental design guidelines applied to telecommunications equipment. The requirements address how to design and build reliable electronics for telecommunications network use.

Primary Sampling – Sampling method relying on the airflow created by an air conditioning or ventilation system to carry air (and smoke if present), to the location of sampling points. For areas that have high airflow, such as data centres or clean rooms, the primary sampling location would be at return air grills, AHUs, or air return ducts.

Restricted Access – Areas that require special permission to enter. Such areas include portions of buildings where people are under restraint or security (prisons or psychiatric wards). Special pieces of equipment are secured, as well as hazardous locations.

Return Air Grill – Grill through which, return air is extracted from a ventilated area, usually not provided with an adjustment for volume of airflow.

Sampling Hole – Any point in the sampling pipe network that draws air into the sampling pipe.

Sampling Pipe – The pipe that sampled air flows through, from the protected area to the ASD unit.

Secondary Sampling – Sampling method used in conjunction with Primary Sampling, involving the configuration of sampling holes at the ceiling level

in similar locations as traditional spot-type smoke detectors. The sampling holes would be spaced in accordance with the appropriate code or standard.

Signal-Processing Equipment – The electronic equipment that performs signal-processing operations such as switching or transport for audio, video, and data signals.

Small Duct – Duct with a width less than 1 m (3 ft.).

Standard Fire Detection (SFD) systems - From NFPA 76: systems that use fire detection-initiating devices to achieve certain life safety and property protection, in accordance with applicable standards.

Telecommunications Equipment – The wire, cable, and electrical/electronic equipment, including signal-processing equipment, cable entrance equipment, power equipment, main distribution frame equipment, and standby engine equipment.

Telecommunications Equipment Area – The area or enclosed room of a telecommunications facility that contains telecommunications equipment.

Terminal Radar Approach Control (TRACON) - facility housing the equipment and personnel that manage and direct departing and approaching aircraft for the airspace (50 miles or 80.5 km diameter zone) of assigned airports.

Transport Time – Time it takes for the smoke particulates to travel from the sampling hole to the ASD sampling chamber.

Very Early Warning Fire Detection (VEWFD) systems – From NFPA 76: systems that detect low-energy fires before the fire conditions threaten telecommunications service.

Honeywell

Tel: +44 (0) 116 246 2000

Fax: +44 (0) 116 246 2300

Email: hlsuksalesupport@honeywell.com

140 Waterside Road

Hamilton Industrial Park

Leicester

LE5 1TN

Honeywell